



© 2022 BMW India Pvt. Ltd. Printed in India 2020.



THE X1

For more information, call 1800 102 2269.

The models, equipment and possible vehicle configurations illustrated in this brochure may differ from vehicles supplied in the Indian market. For precise information, please contact your local Authorised BMW Dealer. Subject to change in design and equipment. © BMW India Pvt. Ltd., Gurgaon, India. Not to be reproduced wholly or in part without written permission of BMW India Pvt. Ltd., Gurgaon, India. [f/bmwindia](#) [YouTube/bmwindia](#) [t/bmwindia](#)

BMW X1



THE NEW BMW X1.



DISCOVER MORE.



Scan the code to get more information and more driving pleasure on the BMW X1.

INNOVATION AND TECHNOLOGY.



15 Drivetrain



16 Safety

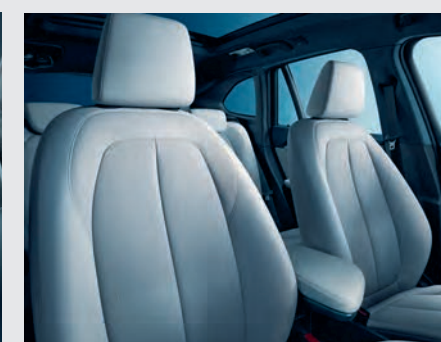

17 Connectivity
17 Comfort and Functionality

EQUIPMENT.



19 Models and Lines



25 Equipment Highlights



29 Wheels and Tyres



30 Original BMW Accessories

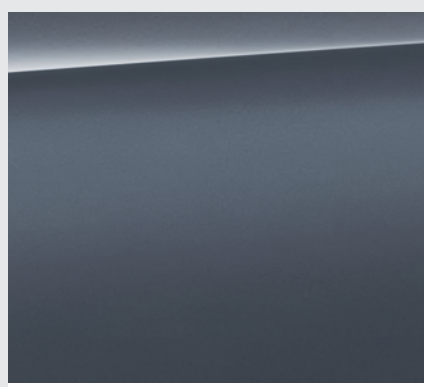

31 Exterior Colours

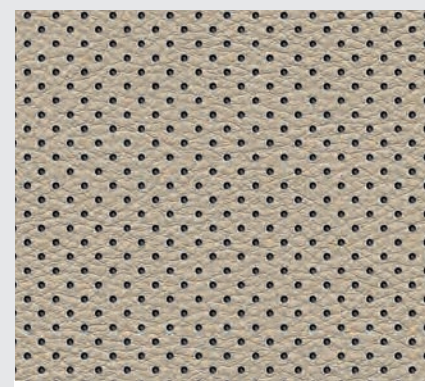

31 Interior Colours

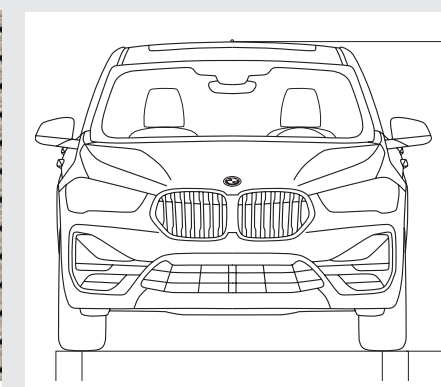

32 Technical Data



WILD
LIFE.



A LOT OF LIFE,
A LOT OF STYLE.





**MAKES
YOU SMILE
FASTER.**





**HERE AND NOW
THERE'S ENOUGH ROOM
FOR A LOT OF WOW.**

**YOUNG, WILD, FAST
LOOKING FOR SUITABLE
COUNTERPART.**





**LONG DISTANCES? SURE.
CONTINUOUS STARES?
ALWAYS.
BORING? NEVER!**



DRIVETRAIN.



ENGINE HIGHLIGHTS OF THE NEW BMW X1.

BMW X1 sDrive20i

BMW TwinPower Turbo 4-Cylinder petrol engine with 141 kW (192 hp) and 280 Nm torque
 Acceleration 0–100 km/h: 7.7 seconds
 Top speed: 226 km/h
 Combined fuel consumption: 14.82 km/l¹
 Combined CO₂ emissions: 155 g/km¹

BMW X1 sDrive20d

BMW TwinPower Turbo 4-Cylinder diesel engine with 140 kW (190 hp) and 400 Nm torque
 Acceleration 0–100 km/h: 7.9 seconds
 Top speed: 222 km/h
 Combined fuel consumption: 19.62 km/l¹
 Combined CO₂ emissions: 133 g/km¹



DYNAMICS AND EFFICIENCY

AERODYNAMICS.

Targeted Aerodynamic changes to the vehicle body such as air vent control, Air Curtain and Air Blades improve its air resistance. The airflow-optimised components contribute not only to reduced fuel consumption, but also reduces the level of noise in the interior.

DRIVING EXPERIENCE CONTROL INCL. ECO PRO.

The Driving Experience Control lets the driver choose between the standard COMFORT mode, ECO PRO mode which is geared towards efficiency, and SPORT mode which enables even more dynamic driving. ECO PRO mode adjusts the characteristics of the accelerator, steptronic transmission and the heating/air conditioning settings to make the drive as fuel-efficient as possible.

LAUNCH CONTROL.

With the Launch Control function, drivers benefit from the best possible acceleration with optimized traction and maximum dynamics from a standstill.

BMW EFFICIENT DYNAMICS.

Get more out of every litre of fuel with BMW Efficient Dynamics: better performance, greater efficiency and a heightened driving pleasure. Technical innovations that lower fuel consumption while simultaneously increasing driving pleasure mean that pure dynamics come standard in every BMW.

BRAKE ENERGY REGENERATION.

With Brake Energy Regeneration, the alternator generates electricity primarily when you brake or take your foot off the accelerator. Previously unused kinetic energy is thereby transformed into electrical energy and fed into the battery.

INTELLIGENT START/STOP FUNCTION.

The Intelligent Auto Start/Stop Function uses data from the navigation system, camera and if it is detected that further travel is imminent (e.g. during a turning manoeuvre), the engine is not automatically switched off when the vehicle stops.

SAFETY.



Attentiveness Assistant analyses the driving behaviour of the driver and suggests when to take a break in the control display. Functions from 70 km/h and higher.

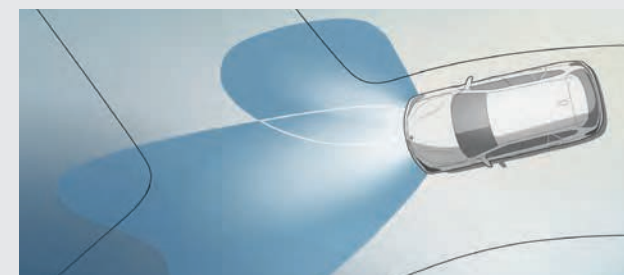

LED Headlights with low-beam and high-beam headlights include LED turn indicators.

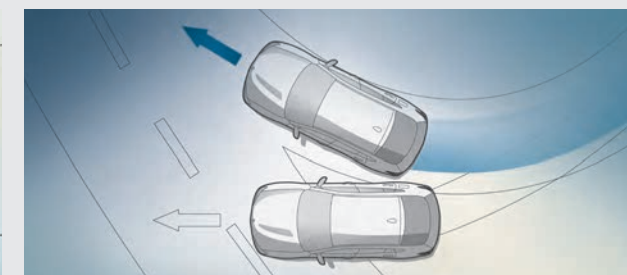

Dynamic Stability Control (DSC) constantly assesses the vehicle's movements and ensures directional stability and traction.

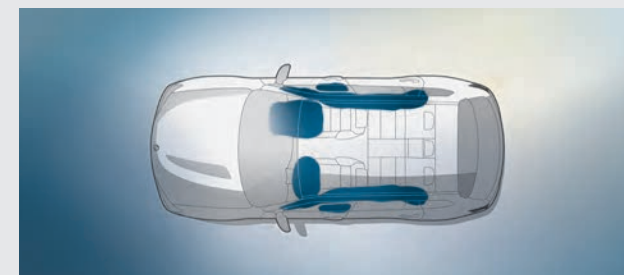

Airbags for driver and front passenger are an integral part of the optimally coordinated safety components in a BMW. A total of six airbags offer targeted protection: driver and front passenger airbags, head airbags for the whole side window area, and side airbags in the front seat backrests.

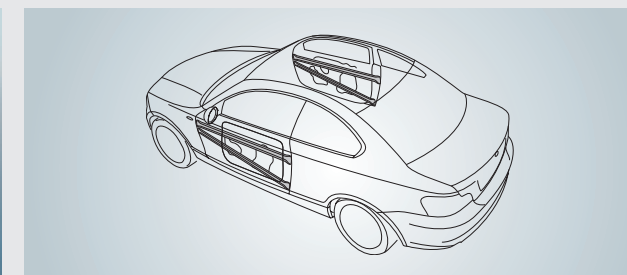

Side-Impact Protection ensures greater safety. Thanks to the directions of the beams and node joints and selective use of high-strength materials, the functionally designed passenger cell structure provides maximum passive safety in the event of a front, side or rear impact.

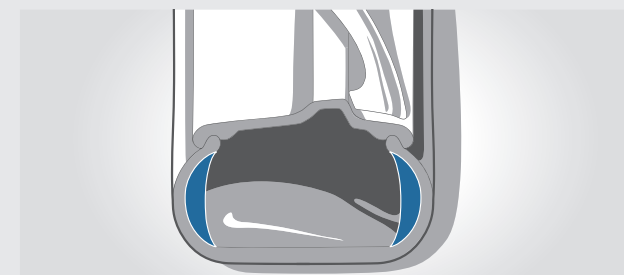

The Runflat Indicator (TDI) warns the driver with a light in the Control Display when there is a slight drop in tyre pressure. When there is a large pressure drop, there is an additional acoustic warning.

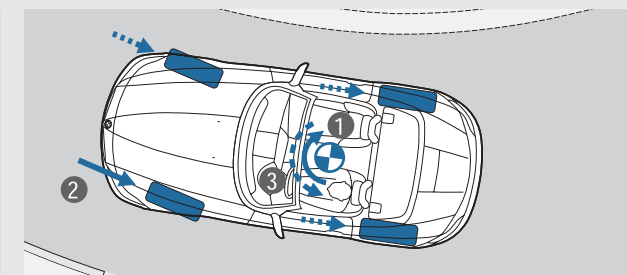

Cornering Brake Control (CBC) helps the driver by applying braking pressure asymmetrically when braking on a bend.

¹ Performance data as measured in the emission test done under controlled conditions of environment, driving cycle, fuel, etc. as specified in Rule 115 of Central Motor Vehicle Rules, 1989.

CONNECTIVITY.

NAVIGATION.

Navigation features an iDrive Controller, a built-in 8.8" (22.3 cm) touch display and an instrument cluster with high-resolution 5.7" (14.4 cm) TFT display. The system is operated intuitively using either the iDrive Controller, the direct menu control buttons and six or eight functional bookmarks, voice control or the touchscreen with interactive tiles.

APPLE CARPLAY.^{1,2}

Why go without the features of your iPhone in your BMW when you can continue operating it as usual? Apple CarPlay^{1,2} gives you remote access to telephony as well as apps like iMessage, WhatsApp, TuneIn, Spotify and Apple Music. You can also use the voice button on the steering wheel to access Siri, Apple's voice assistant.

DISPLAY OPERATING CONCEPT.

In line with the state-of-the-art driver orientation in a BMW, all displays and controls are neatly arranged and within easy reach. They are clearly grouped into the four major categories of driving, comfort, display and operation. This means that new drivers can quickly find their bearings and the amount of time their eyes are diverted from the road is kept to a minimum.



COMFORT AND FUNCTIONALITY.

When open, the **Panorama Glass Roof** provides a great deal of fresh air. Closed, it creates a bright, light-flooded atmosphere in the interior. It opens and closes completely automatically at the push of a button, or remotely, and is equipped with slide and lift functions, roller sunblind and wind deflector.

Options for using the Boot Space are particularly flexible, thanks to the numerous ways in which the rear seats can be adjusted to either increase leg room for the rear passengers or maximise loading space in the luggage compartment, whichever has priority. The rear seat backrest can even be folded down in a 40:20:40 split.

The **Automatic Air Conditioning with 2-Zone Control** and automatic target temperature control features separate controls for you and your front passenger. It also includes Automatic Air Recirculation (AAR), a micro-activated carbon particulate filter, a fogging and solar sensor, as well as rear air vents.

The atmospheric **Lights Package** contains various LED lights and yields an ambience of pure quality in the interior. The six selectable light designs light up the interior with a stylish combination of direct and indirect lights. Additionally, you are greeted with an impressive welcome display of the exterior LEDs incl. "X1" LED projection.

¹ Apps available on Apple CarPlay® is dependent on country specific offer by Apple.

² The compatibility and range of functions from Apple CarPlay® depend on the model year and the software installed on the iPhone®. When the Apple CarPlay® preparation is used, selected vehicle data is transferred to the phone. The mobile phone manufacturer is responsible for further data processing.





The **Electric Seat Adjustment** is easy to use and the memory function allows users to save their preferred settings for the seat and exterior mirrors.



Automatic Air Conditioning with 2-Zone Control includes temperature control for driver and front passenger, automatic air recirculation and carbon microfilter.



The **Multifunction Steering Wheel** can be used to operate the telephone, voice control and audio functions via the buttons on it. The Manual Speed Limiter is also integrated. For example, it can be used to set an upper limit of 50 km/h for city driving.



When open, the **Panorama Glass Roof** provides a great deal of fresh air. When closed, it creates a bright, light-flooded atmosphere in the interior. It opens and closes completely automatically at the push of a button, or remotely, and is equipped with slide and lift functions, roller sunblind and wind deflector.

Standard Model Equipment:

- Full LED Headlamps with hexagon icon design
- Full LED Tail Lights with L-shaped design, dark version with dynamic brake light
- Panoramic Glass Roof
- Aerodynamically optimised vehicle underbody
- Rain Sensor and Automatic Driving Lights
- Exterior mirror electric folding with automatic anti-dazzle and parking function
- Standard Seat for driver and front passenger
- Electrical Seat Adjustment for driver and passenger with memory function for driver
- Front armrest, sliding with storage compartment
- Centre armrest in the rear with 2 cup holders
- Sport Leather Steering Wheel with multifunction
- Floor Mats in velour
- Rear seat 40:20:40 split
- Rear-View Camera
- Park Distance Control, Rear
- Interior mirrors with automatic anti-dazzle function
- Driving Experience Control incl. ECO PRO
- Performance Control
- Cruise Control with Braking Function
- Automatic Air Conditioning with 2-Zone Control
- Storage Compartment Package
- Media unit with 6.5" (16.5 cm) Control Display with touch and six loudspeakers

Interior Design:

- Door Sill Finishers in Black Matt with BMW designation in Black High-Gloss
- Interior trim finishers Black High-Gloss with highlight trim finisher Pearl Chrome

Exterior Design:

- BMW Kidney Grille frame in High-Gloss Chrome with grille struts in High-Gloss Black
- Trim for front air guide, centre in Black Silver
- Window side frame in Matt Black with embellishers for B pillar in Black High-Gloss
- Mirror Cap painted in body colour
- Roof Rails in Black Matt finish
- Twin exhaust tail-pipe in Chrome High-Gloss finish
- 17" light alloy wheels style 564



The **Comfort Suspension** makes driving particularly comfortable with high driving dynamics and makes it easier to get in and out and load the vehicle.



LED Headlights with low-beam and high-beam headlights include LED turn indicators.



Apple CarPlay^{1,2} gives you remote access to telephony as well as apps like iMessage, WhatsApp, TuneIn, Spotify and Apple Music. You can also use the voice button on the steering wheel to access Siri, Apple's voice assistant.



The **Lights Package** also includes a welcome greeting. When the vehicle is unlocked, an LED light source in the driver's-side exterior mirror projects the characters "X1" onto the ground.

Interior Design:

- Door Sill Finishers, front with Aluminium finishers and "BMW" designation
- Sport Seats for driver and front passenger in Sensatec upholstery
- Vehicle Key with Pearl Chrome detailing
- Accent stitchings on the centre console and the instrument panel
- Interior trim in Fine-Wood 'Fineline' Stream with highlight trim finishers Pearl Chrome
- Ambient Lighting with exclusive LED optical fibre in the door trims with six selectable light designs
- Loading Sill Trim in Stainless Steel
- Navigation System with 8.8" touch display and instrument cluster with high-resolution 5.7" (14.4 cm) TFT display
- Wireless Apple Carplay^{1,2}

Exterior Design:

- BMW Kidney Grille with exclusively designed vertical slats with front sides in Aluminium Matt, grille frame in Chrome High-Gloss
- Front Bumper with sump guard and other design elements in Silver Matt
- Fog Lights integrated into the bumper system, each with 3 LEDs in horizontal arrangement
- Side Skirt trim in Silver Matt
- Roof Rails in Aluminium Satinated
- Sump guard in the back with main part in body colour and inset trim painted Silver
- 17" light alloy wheels style 564



The **Seats** for driver and front passenger can be electrically adjusted in a variety of ways and provide a perfect seating position for a relaxed arrival.



The **Navigation System** provides the driver with an innovative 8.8" (22.3 cm) touch display concept and numerous functions for navigation, office and multimedia for maximum comfort and information en route to your destination.



The BMW X1 surprises with its **Innovative and Sophisticated Design** of the customary driver oriented cockpit layout. While its fine materials and top class finishing impress from the very first look.

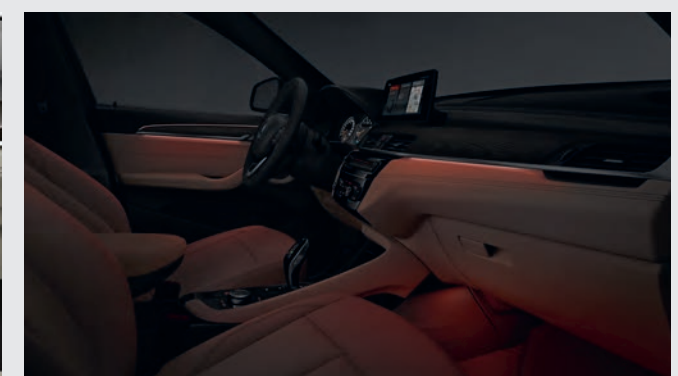

The **Atmospheric Lights Package** contains various LED lights and yields an ambience of pure quality in the interior. The six selectable light designs light up the interior with a style.

¹ Apps available on Apple CarPlay[®] is dependent on country specific offer by Apple.
² The compatibility and range of functions from Apple CarPlay[®] depend on the model year and the software installed on the iPhone[®]. When the Apple CarPlay[®] preparation is used, selected vehicle data is transferred to the phone. The mobile phone manufacturer is responsible for further data processing.

M SPORT.

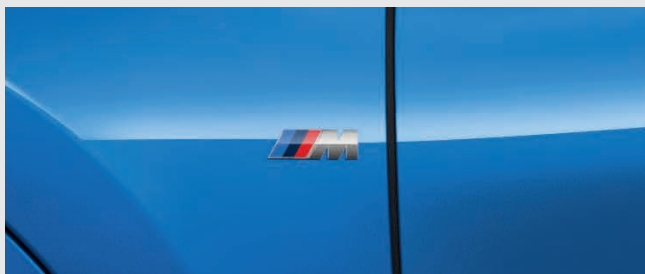

M logo on the sides.



Door Sill Finishers with exclusive 'M' badge.

Interior Design:

- Door Sill Finishers with 'M' lettering
- Floor Mats in M design
- Sport Seats for driver and front passenger
- Leather 'Dakota' upholstery
- Accent stitchings on the centre console and the instrument panel
- M Leather Steering Wheel
- Vehicle Key with exclusive M designation
- BMW Individual Headliner Anthracite
- Interior trim in Fine-Wood 'Fineline' Stream with highlight trim finishers Pearl Chrome

Exterior Design:

- M Aerodynamics Package with front apron, side skirts, wheel arch trim and cladding in body colour, rear apron with diffuser insert in Dark Shadow Metallic
- BMW Kidney Grille with exclusively designed vertical slats with front sides in Black High-Gloss, grille frame in Chrome High-Gloss
- LED Fog Lights integrated into the bumper system, each with 3 LEDs in horizontal arrangement
- Window exterior frame in Satinized Aluminium
- M logo on the sides
- Roof Rails in Aluminium Satinated
- 18" M light alloy wheels Double-spoke style 570 M Bicolour



The **Sport Seats** for driver and front passenger are characterised by seat and backrest bolsters that are larger than those on the standard seats and, together with adjustable thigh support, for excellent ergonomics and better lateral support during fast cornering. In addition to the seat depth (mechanical), the backrest width (electric) can also be adjusted on the driver's seat.



The **M Leather Steering Wheel** including multifunction buttons, an M badge and an integrated driverside airbag is featured in three-spoke design. With a steering wheel rim in Leather Black with Black stitching and contoured thumb rests, it provides a direct, athletic steering experience.



The **M Aerodynamics Design Package** brings out the sporty appeal of the vehicle.



The **Hi-Fi Loudspeaker System** lets you enjoy your favourite music in superb fidelity, thanks to the powerful amplifier, sophisticated equalizer and high-performance speakers.

EQUIPMENT HIGHLIGHTS.



When open, the **Panorama Glass Roof** provides a great deal of fresh air. When closed, it creates a bright, light-flooded atmosphere in the interior. It opens and closes completely automatically at the push of a button, or remotely, and is equipped with slide and lift functions, roller sunblind and wind deflector.



From the daytime running lights to the low-beams and high-beams, all of the functions in the **LED Headlights** have a longer lifespan and save more energy thanks to LED technology. The dynamic, flat headlights feature increased visibility at night and in bad weather, thanks to excellent illumination with a light colour similar to daylight.



The **Comfort Suspension** makes driving particularly comfortable with high driving dynamics and makes it easier to get in and out and load the vehicle.

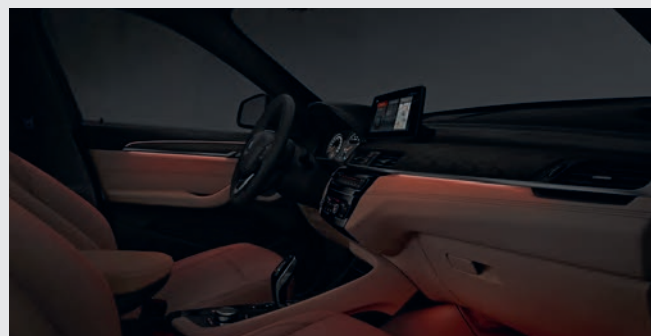

The **Atmospheric Lights Package** contains various LED lights and yields an ambience of pure quality in the interior. The six selectable light designs light up the interior with a style.



LED Fog Lights increase short-range visibility in fog or precipitation, improving night-time driving safety.



The **Lights Package** also includes a welcome greeting. When the vehicle is unlocked, an LED light source in the driver's-side exterior mirror projects the characters "X1" onto the ground.



Automatic Air Conditioning with 2-Zone Control includes temperature control for driver and front passenger, automatic air recirculation and carbon microfilter.



Micro-activated Carbon Particulate Filter for fresh and recirculated air.



The **Rain Sensor** including automatic headlight activation automatically activates the windscreen wipers and the low-beam headlights.



Interior and driver-side exterior mirrors with Automatic Anti-dazzle Function, including **Fold in function for the Exterior Mirrors** and automatic parking function for the front passenger exterior mirror.

EQUIPMENT HIGHLIGHTS.



The **Navigation System** provides the driver with an innovative 8.8" (22.3 cm) touch display concept and numerous functions for navigation, office and multimedia for maximum comfort and information en route to your destination.



The **40:20:40 Split-folding** rear seat bench with backrest manually adjustable to three ways makes loading even easier and the vehicle even more versatile.



Apple CarPlay^{1,2} gives you remote access to telephony as well as apps like iMessage, WhatsApp, TuneIn, Spotify and Apple Music. You can also use the voice button on the steering wheel to access Siri, Apple's voice assistant.



The **Instrument Cluster** designed in Black-Panel technology, has a Matt Black surface with two fine Chrome rings and is integrated into the instrument panel in a modern and elegant way.



The **Electric Seat Adjustment** is easy to use and the memory function allows users to save their preferred settings for the seat and exterior mirrors.



The **Multifunction Steering Wheel** can be used to operate the telephone, voice control and audio functions via the buttons on the steering wheel. The Manual Speed Limiter is also integrated. For example, it can be used to set an upper limit of 50 km/h for city driving.



The **Hi-Fi Loudspeaker System** lets you enjoy your favourite music in superb fidelity, thanks to the powerful amplifier, sophisticated equalizer and high-performance speakers.



The **Park Distance Control (PDC) with Rear View Camera** allows for easy parking and manoeuvring in confined spaces. Acoustic signals and a visual indicator in the Control Display tell you when the rear of the vehicle is approaching an object. Distances are measured by ultrasound sensors in the bumper.



The interior mirror and driver-side exterior mirror feature the **Automatic Anti-dazzle Function**. Additionally, the driver-side exterior mirror features the automatic curb parking function when the vehicle is put in reverse. Both exterior mirrors are equipped with an electric folding function, as well as a mirror memory function. That makes parking easier and helps to avoid damage to the vehicle.



The **8-Speed Steptronic Transmission** and **7-Speed Steptronic Transmission** with double clutch technology combines efficiency with smooth gearshifts and outstanding driving comfort, thanks to tightly spaced gear ratios and fast engine speed transitions. It therefore unites superb comfort with impressive dynamics and increased fuel efficiency.

¹ Apps available on Apple CarPlay® is dependent on country specific offer by Apple.

² The compatibility and range of functions from Apple CarPlay® depend on the model year and the software installed on the iPhone®. When the Apple CarPlay® preparation is used, selected vehicle data is transferred to the phone. The mobile phone manufacturer is responsible for further data processing.



Scan to visit the BMW Accessories Configurator



The **BMW High-Gloss Black Kidney Grille** gives the front of the car an even more dynamic and athletic look. The glossy Black surrounds make the air inlet appear more striking and bigger than ever.

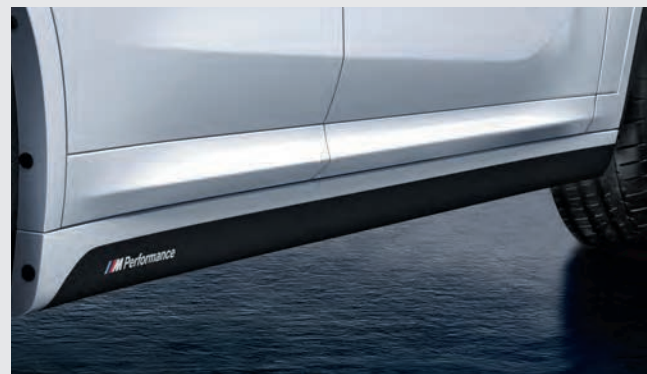

The **Side Skirt Transfers** in Black perfectly complement the vehicle's design, underscoring its individual, athletic profile, with coloured BMW M Performance lettering.



BMW M Performance Exterior Mirror Caps, Carbon Fibre.



Key Case, Alcantara/Carbon Fibre. The key case's material mix of carbon fibre and Alcantara is highly captivating. With accents in BMW M Blue.



M Performance Floor Mats, Front and Rear. No compromises, not even in the footwells. The BMW M Performance floor mats perfectly round out the upscale, dynamic appearance of the car's interior. Premium look. Optimal traction.

WHEELS AND TYRES.



17" light alloy wheels Double-spoke style 564
Reflex Silver wheel size 7.5J x 17 with 225/55 R17 tyres.



17" light alloy wheels Double-spoke style 385
Reflex Silver, wheel size 7.5J x 17 with 225/55 R17 tyres.



18" light alloy wheels Double-spoke style 568
Ferric Grey, gloss-lathed, 7.5J x 18 with 225/50 R18 tyres.



18" light alloy wheels Double-spoke style 578
Jet Black, wheel size 7.5J x 18 with 225/50 R18 tyres.

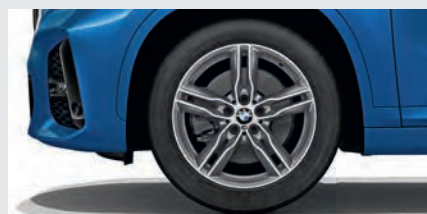

18" M light alloy wheels Double-spoke style 570
M Bicolour Ferric Grey gloss-lathed, 7.5J x 18 with 225/50 R18 tyres.

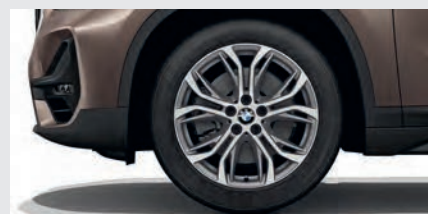

18" light alloy wheels Y-spoke style 566,
Ferric Grey, gloss lathed, wheel size 7.5J x 18 with 225/50 R18 tyres.

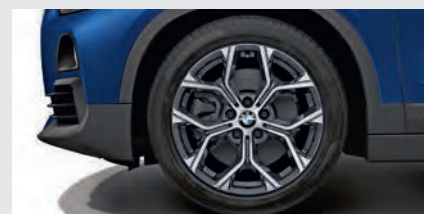

18" light alloy wheels Y-spoke style 579,
Orbit Grey, wheel size 7.5J x 18 with 225/50 R18 tyres.

Alloys shown in the brochure are subject to availability.

TRAVEL AND COMFORT ACCESSORIES.



The **BMW Spectacle Case** with BMW designation keeps glasses stowed safely and easily within reach.



Travel & Comfort System – Universal Cradle.¹



BMW Baby Seat Group 0+ and BMW Junior Seat Group 1 & 2/3 can be adjusted as the child grows and offers maximum safety and comfort for children aged up to 12 years.



Travel & Comfort System – Clothes Hanger.¹ The Travel & Comfort System clothes hanger in an attractive BMW design makes it possible to hang pieces of clothing on the rear side of the backrest.

ORIGINAL BMW ACCESSORIES.



With the **BMW Wireless Charging Station Universal** smartphones can be charged comfortably and efficiently without a cable, any time and anywhere.



Advanced Car Eye 2.0. A highly sensitive full-HD camera that captures events in front and behind the car, even when it is parked.



Sunblind² for the rear side window protects the interior from sunlight and offers privacy.

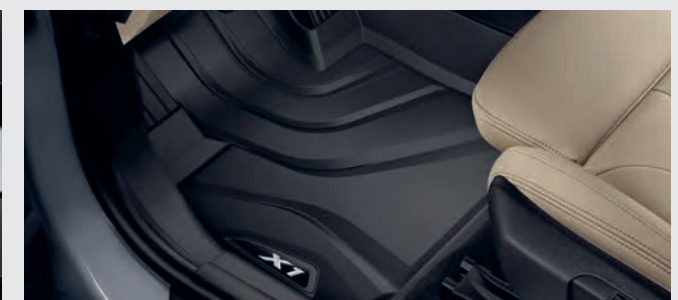

All Weather Floor Mats protect against moisture and dirt in the front footwell. Featuring a Black design with a stainless steel inlay, they complement the interior.

¹Only in conjunction with base carrier.

²Accessory will be available from July, 2020 onwards.

EXTERIOR COLOURS.



Alpine White (Non-Metallic)

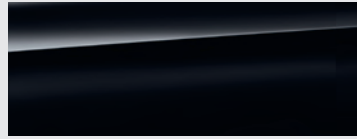

Black (Non-Metallic)



Mineral White (Metallic)



Black Sapphire (Metallic)



Sparkling Brown (Metallic)



Sunset Orange (Metallic)



Mediterranean Blue (Metallic)



Misano Blue (Metallic)

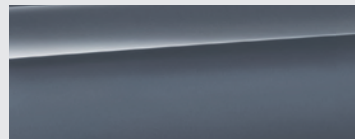

Storm Bay (Metallic)

INTERIOR COLOURS.

UPHOLSTERY.

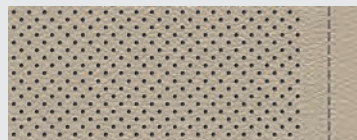

Leather 'Dakota' with perforations Oyster and Grey highlight

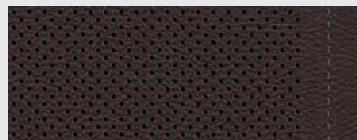

Leather 'Dakota' with perforations Mocha

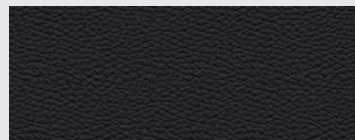

Leather 'Dakota' | Black

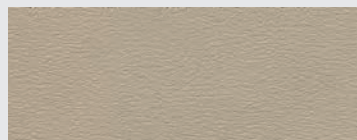

Sensatec | Oyster

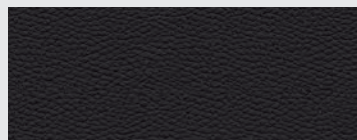

Sensatec | Black

INTERIOR TRIMS.



Black High-Gloss with highlight trim finisher Pearl Chrome

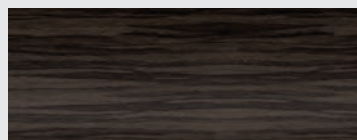

Fine-Wood trim 'Fineline' Stream with accent in Pearl Chrome

DIMENSIONS.

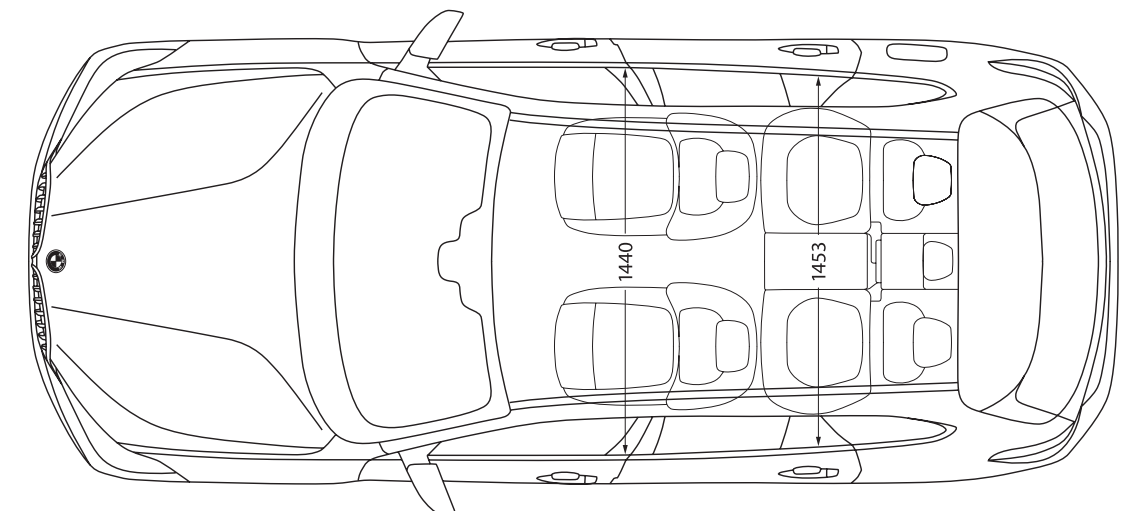
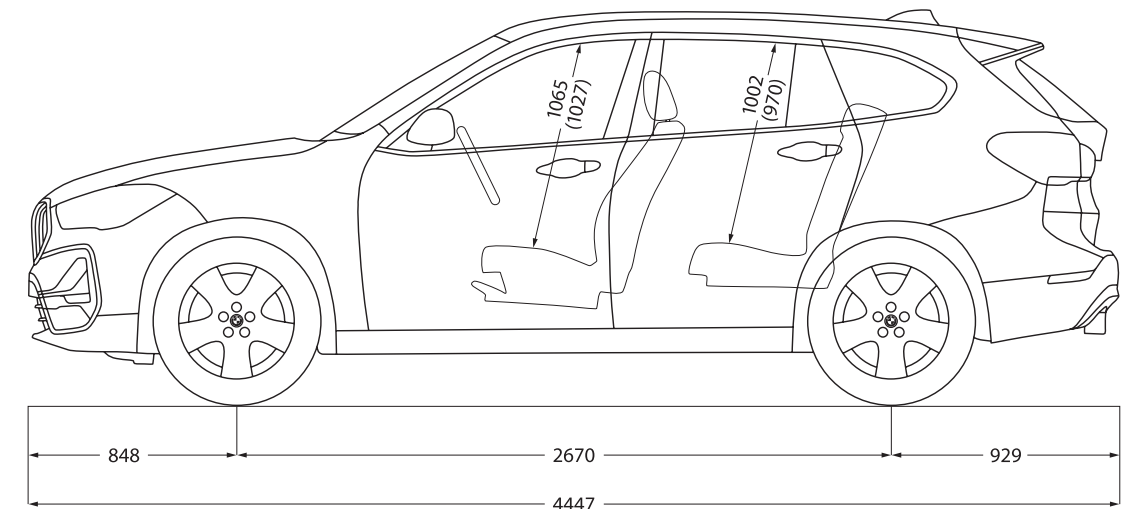
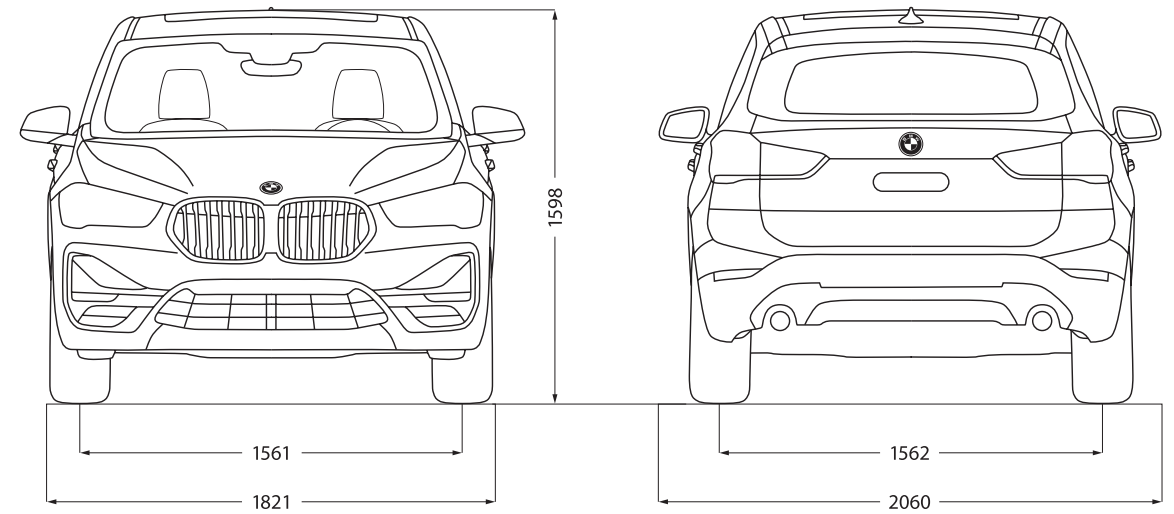

[Colours] The colours printed above are intended to provide you with a first impression of paints and materials available for your BMW. Experience has shown, however, that printed images of paint, upholstery and interior trim colours cannot faithfully reproduce

the actual appearance of the originals. We recommend therefore that you consult your BMW partner who will be able to show you original samples and assist with special requests.

BMW EXTENDED WARRANTY AND SERVICE PACKAGE.



A BMW X1 will run well when it's kept well. And to make your journey one with complete peace of mind, we have packages under BMW Service and Repair Inclusive that take care of maintenance, inspection, wear and tear and warranty.

BMW Service Inclusive (BSI)

A single up-front payment covers an extensive range of work on your BMW X1 for a fixed period.

Complete Cost Control.²

Integrate the cost of service work in your leasing and finance installments.

Fully Flexible.

You have a choice of various packages with different durations and mileage. You can choose from 3 years with 40,000 km to 10 years with 2,00,000 km.

Easily Transferable.

Consistent maintenance by trained BMW Certified Technicians and the use of Original BMW Parts secure the value of your car in the long term. In case you sell your car, BMW Service Inclusive is automatically transferred to the next owner – an additional selling point.

BMW Repair Inclusive (BRI)

BRI offers the ease of extending the warranty of your car with unlimited mileage up to 5 years.

BRI too is automatically transferred to the next owner in the event of selling your car.

¹Service packages starting at ₹0.97 per Km.

Service Inclusive Packages		Oil Inclusive	Service Inclusive Basic	Service Inclusive Plus	Repair Inclusive
Scope of Services		Maintenance Engine oil service.	Maintenance All maintenance work, including any BMW Original Parts and oil required.	Wear and Tear Additional wear and tear repairs including any Original BMW Parts required.	Repair Extension of your statutory right to claim for vehicle defects (warranty).
Maintenance	Engine oil service	✓	✓	✓	
	Engine oil top ups		✓	✓	
	Vehicle check and standard scopes		✓	✓	
	Service/replace air filter		✓	✓	
	Service/replace fuel filter		✓	✓	
	Service/replace micro filter		✓	✓	
	Service/replace spark plugs		✓	✓	
	Service/replace brake fluid		✓	✓	
Wear & Tear	Replacement of front/rear brake pads			✓	
	Replacement of front/rear brake discs			✓	
	Replacement of clutch (if necessary)			✓	
	Replacement of wiper blades (once in a year)			✓	
Extension of your statutory right to claim for vehicle defects (warranty ¹)					✓

BMW FINANCIAL SERVICES.

BMW Financial Services
Realize the dream.



In the world of BMW, world-class isn't limited to the vehicles we engineer. It also finds its way into the services we offer. BMW Financial Services is the most flexible and efficient way to realise your dream of owning a BMW. Our goal is to make your financing experience seamless at every step of your purchase so that nothing comes between you and the joy of driving your BMW.

At BMW Financial Services, you are assured of:

- Tailor-made finance options, as per your specific needs
- Quick approvals with fast turnaround time
- Special loyalty benefits
- Part payment facility
- In-house call centre that provides the best-in-class customer interaction

The BMW X1 comes with an exclusive BMW 360° Plan. It has benefits at every step of the way, all to ensure Sheer Driving Pleasure.

Easy to Buy.

The BMW 360° Plan allows you to pay low monthly installments as you only pay for what you use.

Easy to Own.

BMW offers various options under Service and Maintenance Packages which further reduce your cost of ownership.

Future Proof.

The BMW 360° Plan provides Assured Buyback value at the end of your finance contract.

For more information, contact the Finance and Insurance Manager at the nearest BMW Authorised Dealership.

¹ Terms and conditions apply.

² Applicable only with BMW India Financial Services Private Limited during the initial purchase of the vehicle (not on other finance or during upgrades).

BMW INDIA NETWORK.

DEALERSHIPS.

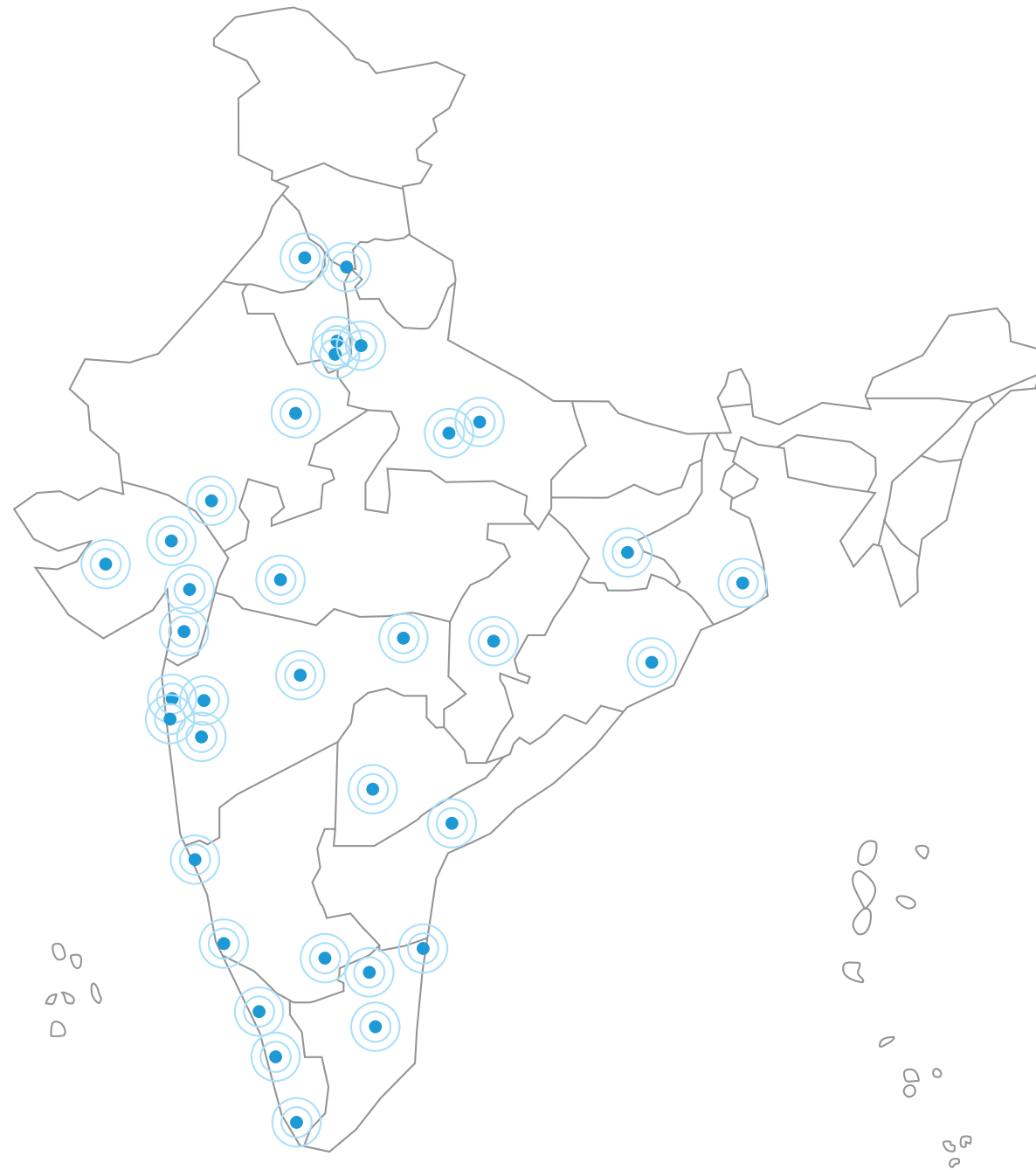

NORTH

BMW Bird Automotive

- SW 4IDC, MG Road, Gurugram
- S Golf Course Road, Sector 56 Gurugram

BMW Deutsche Motoren

- S Mohan Cooperative, Mathura Road New Delhi
- W Shivaji Marg, Moti Nagar, New Delhi
- SW Sector 27B, Mathura Road, Faridabad
- SW Sector 63, Noida

BMW Infinity Cars

- S Rajouri Garden, New Delhi
- W Mayapuri, New Delhi

BMW Krishna Automobiles

- SW Industrial Phase 1, Chandigarh
- SW GT Road, Ludhiana

BMW Sanghi Classic

- SW Tonk Road, Jaipur
- S Madri Industrial Area, Udaipur

BMW Speed Motorwagen

- SW Chinhat, Lucknow
- SW Kalpi Road, Kanpur

EAST

BMW OSL Prestige

- S Silver Arcade, Kolkata
- W East Topsia Road, Kolkata
- SW Bhanpur, Cuttack

BMW Titanium Autos

- SW Ormanjhi, Ranchi

WEST

BMW Bavaria Motors

- S Wellesley Road, Pune
- W Hadapsar, Pune
- SW Verna, Goa
- SW Chikalthana, Aurangabad

BMW Eminent Cars

- SW Surat-Dumas Road, Piplod, Surat
- SW Sunpharma Road, Vadodara

BMW Gallops Autohaus

- SW S G Highway, Sarkhej, Ahmedabad
- SW Gondal Road, Rajkot

BMW Infinity Cars

- S Worli, Mumbai
- S Nariman Point, Mumbai
- S Vashi, Navi Mumbai
- W Lalbaug, Mumbai
- W Worli, Mumbai
- W Turbhe, Navi Mumbai
- SW Dewas Naka, Indore

BMW Munich Motors

- SW Sarona, Raipur
- SW Hingna MIDC, Nagpur

BMW Navnit Motors

- S Juhu, Mumbai
- S Malad, Mumbai
- W Andheri, Mumbai
- W Gokul Nagar, Thane

SOUTH

BMW Deutsche Motoren

- S Whitefield, Bengaluru
- W Whitefield, Bengaluru

BMW EVM Autokraft

- SW Kalamassery, Kochi
- S Kovalam Road, Trivandrum
- W Kochuveli, Trivandrum

BMW KUN Exclusive

- S Khairtabad, Hyderabad
- S Jubilee Hill, Hyderabad
- W RTC, Cross Road, Hyderabad
- SW Mangalagiri, Vijayawada

BMW KUN Exclusive

- SW Meenambakkam, Chennai
- S EA Mall, Chennai
- S Ambattur, Chennai
- S OMR, Chennai
- W Ambattur, Chennai
- SW Avinashi Road, Coimbatore
- SW Virudhunagar, Madurai

BMW Varsha Autohaus

- SW Mangalore-Bangalore Highway, Mangalore

BMW Navnit Motors

- S Lavelle Road, Bengaluru
- W Bethahalasoor Post, Bengaluru
- SW Hosur Road, Bengaluru

SW Showroom and Workshop S Showroom W Workshop

SEARCH



Scan to visit the BMW Online Shop

The pictorial representation does not purport to be the political map of India.