



All New
AMAZE
Here to Outclass



HERE TO

OUTCLASS

When confident design philosophy meets cutting-edge technology, something truly outclass is born. In the new 3rd generation Honda Amaze, you'll find intelligent features working seamlessly in a spacious and comfortable cabin to give you a feeling that's nothing but outclass.



GENERATION 1



OUTLASTING LEGACY

Great legacies grow stronger with time, and the new Honda Amaze is a testament to it. Since its inception, Amaze has captured the hearts of Indians and continues to surpass expectations. Delivering on the promise of comfort, performance, and elegance.

GENERATION 2



GENERATION 3

OUTCLASS

EXTERIOR

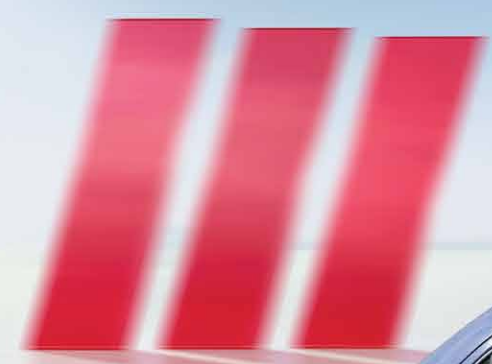

AN IMPRESSION TO REMEMBER

When you look at the new Honda Amaze, you can't help but notice its imposing front face. The signature chequered flag pattern grille and the elegant rear design come together to create a progressive, classy, and impactful look.

SIGNATURE CHEQUERED FLAG PATTERN GRILLE



ELEGANT & STRONG REAR DESIGN





LED PROJECTOR HEADLAMPS WITH INTEGRATED DRLS & TURN INDICATORS

LED PROJECTOR FOG LAMPS



SHARK-FIN ANTENNA

ICONIC WING-SHAPED LED REAR LIGHTS



CLASSY DIAMOND-CUT ALLOY WHEELS

CHOOSE YOUR STYLE



RADIANT RED METALLIC



NEW

OBSIDIAN BLUE PEARL



GOLDEN BROWN METALLIC



METEOROID GREY METALLIC



LUNAR SILVER METALLIC



PLATINUM WHITE PEARL

OUTCLASS
INTERIOR





A SANCTUARY OF REFRESHED ELEGANCE

Inside the new Honda Amaze, you're taken over by a refreshed feeling of freedom. The thoughtfully curated combination of smart features ensures that everything you want is always within your reach.

FLOATING 20.32 CM (8")
ADVANCED HD DISPLAY AUDIO



17.7 CM (7") HD FULL COLOUR TFT
MULTI-INFORMATION DISPLAY METER



WIRELESS SMARTPHONE
CHARGER



WIRELESS CONNECTIVITY –
APPLE CARPLAY® & ANDROID AUTO™

INTERIOR

PM 2.5 CABIN AIR PURIFYING FILTER



IMMERSIVE 6 SPEAKER SOUND SYSTEM



FULLY AUTOMATIC CLIMATE CONTROL WITH MAX COOL



ONE-TOUCH PUSH START/ STOP



OUTCLASS

SAFETY



Honda SENSING

INTELLIGENT ADAS TECHNOLOGY



FIRST-IN-SEGMENT°

SAFETY FOR EVERYONE

We at Honda wish to build a collision-free society, where not only the drivers but everyone sharing the road can confidently enjoy the freedom of mobility. Which is why, the new Honda Amaze is equipped with more than 28 active and passive safety features.

Honda SENSING*, Honda's iconic Advanced Driver Assistance System (ADAS) helps minimize the risk of accidents, by sensing the environment around the car. Giving you and your loved ones the confidence of a safe drive, every time.



LANE KEEPING ASSIST SYSTEM (LKAS)

Steers the wheel to keep you in the middle of the lane while cruising along the highway.



ROAD DEPARTURE MITIGATION SYSTEM

When the car seems to deviate from road boundaries, it gives audio-visual alerts with steering wheel support.



ADAPTIVE CRUISE CONTROL (ACC)

Accelerates and brakes to keep you at a safe distance from other cars while cruising.

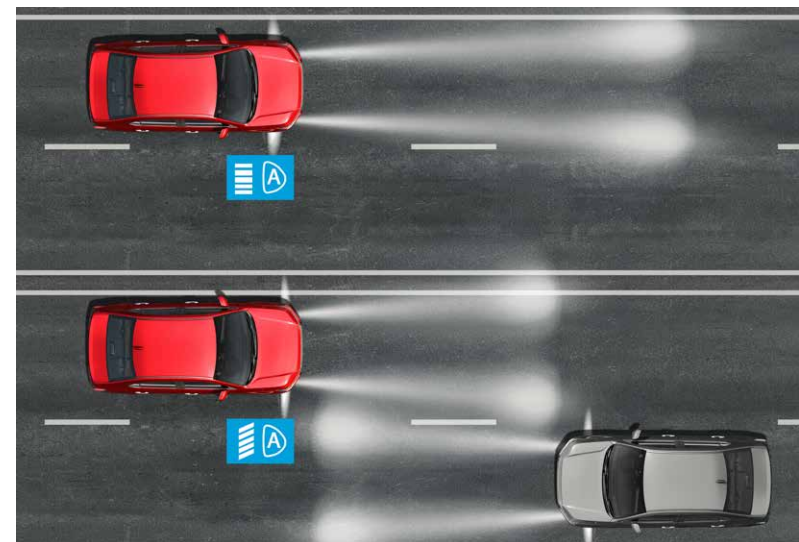
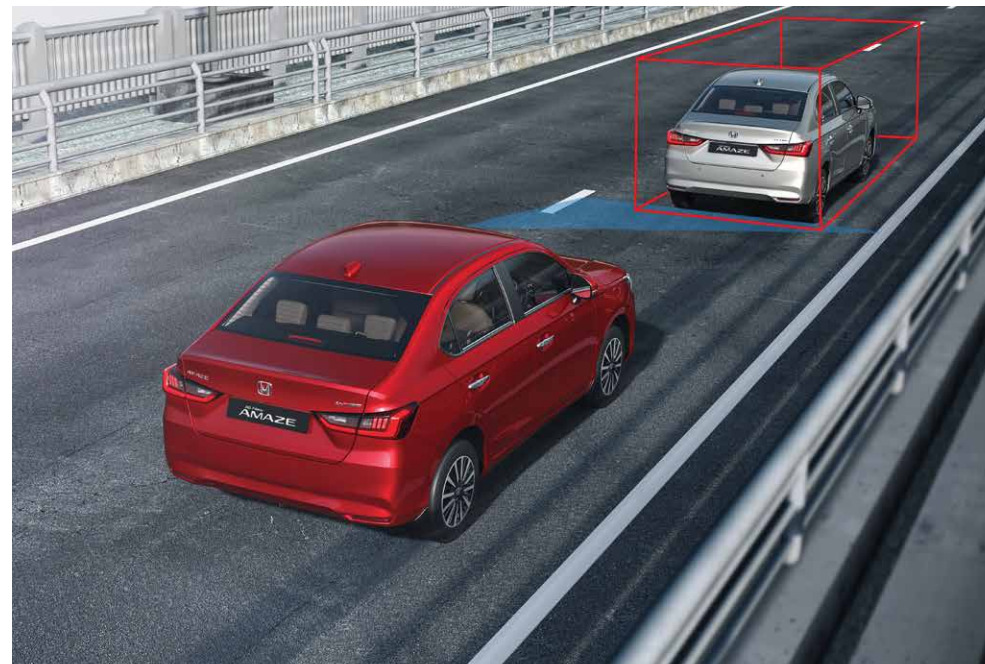

COLLISION MITIGATION BRAKING SYSTEM (CMBS)

Provides audio & visual warning alerts and applies brakes when there is a risk of collision.

AUTO HIGH-BEAM

Improves visibility by automatically switching between low and high beam.

LEAD CAR DEPARTURE NOTIFICATION SYSTEM

Notifies you when the car ahead departs.



ACE™ BODY STRUCTURE

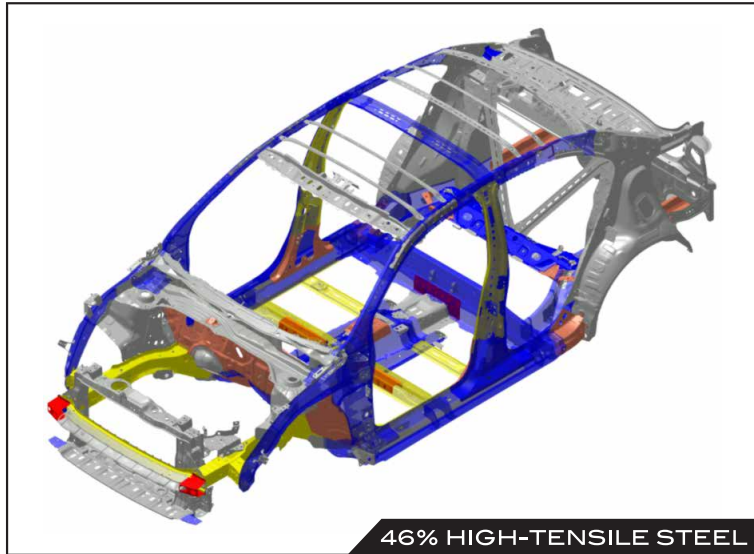

46% HIGH-TENSILE STEEL

6 AIRBAGS STANDARD ACROSS ALL VARIANTS



LANEWATCH™ CAMERA



FIRST-IN-SEGMENT*



MULTI-ANGLE REAR CAMERA WITH GUIDELINES



HILL START ASSIST



VEHICLE STABILITY ASSIST

REAR PARKING SENSORS

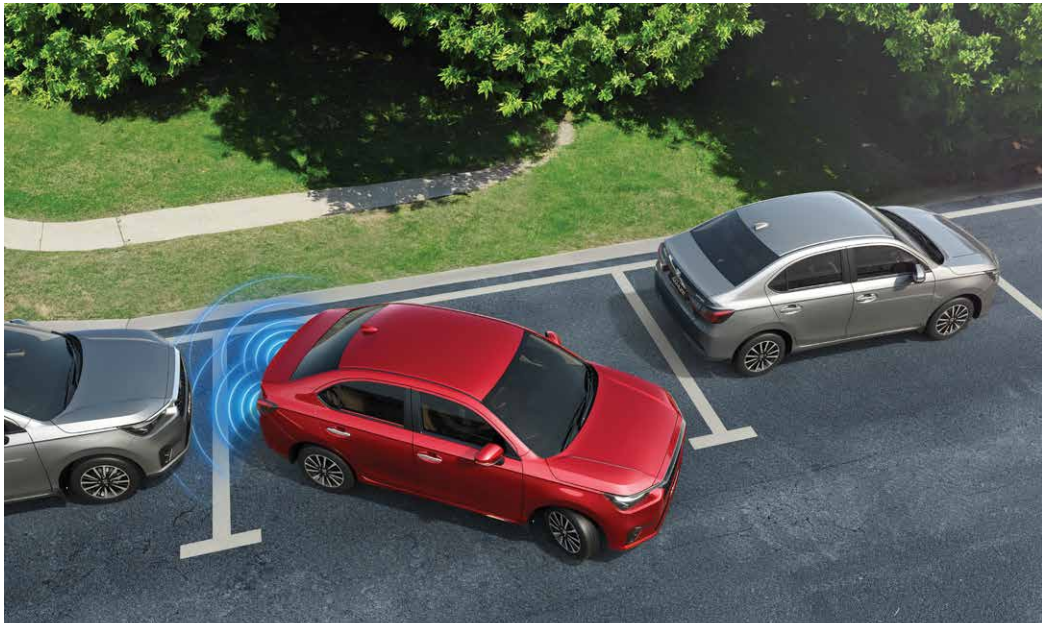

SEAT BELT REMINDER (ALL SEATS)



ISOFIX ANCHORAGES & TETHER

ANTI-LOCK BRAKING SYSTEM (ABS)
WITH ELECTRONIC BRAKE-FORCE DISTRIBUTION (EBD)



RAIN WIPERS WITH
HEADLIGHT INTEGRATION

EMERGENCY STOP SIGNAL



ANTI-PINCH WINDOW (DRIVER SIDE)



OUTCLASS

CONNECTIVITY



Honda CONNECT



INDUSTRY
FIRST
5
YEAR
FREE SUBSCRIPTION*

CONNECTED. ANYTIME. ANYWHERE.

Honda Connect is a combination of smart, convenient and thoughtful features. This comprehensive package helps you always stay connected with your Honda Amaze.



SMARTWATCH CONNECTIVITY



ALEXA REMOTE CAPABILITY

*Honda Connect comes with free subscription for first 5 years from the date of purchase.

Honda CONNECT



SCAN TO DOWNLOAD THE APP



i NOW KNOW MORE ABOUT THE SMART FEATURES WITH DEMO MODE IN HONDA CONNECT APP.

T&C applicable. Honda Connect application works on smartphones: Android 7.0 & above; iOS 11.0 & above. Honda Connect application works with select smartwatch devices. Smartwatch is not part of car accessory/ giveaway and need to be purchased separately. All services and features of Honda Connect are subject to network availability, facility/ transmission limitations as per government regulation and permissions in specific regions/ locations. Selective alerts work as per user settings and in select car models/ transmission. Actual application/ features may differ from representative images shown above. Digital Pick & Drop is an additional convenience to customer and dealer specific facility. Tracking through digital pick & drop is subjected to network conditions. *TPMS and DVR features are not a part of standard Honda Connect Features package. Customer requires to purchase TPMS or/ and DVR accessories to use these features. For more details visit your nearest Honda Car dealership or www.hondacarindia.com. Alexa Remote Capability supported features can be executed via Honda Skill through Alexa, enabled device as per user input information in the Honda Connect App. Amazon, Alexa and all related logos are trademarks of amazon.com, Inc. or its affiliates. Alexa device is not part of car accessory/ giveaway and needs to be purchased separately. Actual device may differ from the one shown here. Please refer to amazon.com for more details.

PEACE OF MIND

Worrying about the status of your car is a thing of the past.
Features that keep your every journey, stress-free.

Service Scheduler | Tow Away Alert | RSA Request & Tracking | Payment Gateway
Tyre Pressure Monitoring System (TPMS)* | Fuel Pay
and many more...

SAFETY & SECURITY

At Honda, safety isn't just a feature, it's a priority.
Reliable security features that ensure the safety of you and your car.

Car Location | Geo-Fence Alert | Auto Crash Notification | Drive View Recorder (DVR)*
Stolen Vehicle Tracking | Contextual Speeding Alert | Unauthorized Access Alert
and many more...

CONVENIENCE

Convenience is essential, period. A bouquet of thoughtfully selected
features that make your every drive, truly effortless.

Find My Car | Digital Pick & Drop | Honda Connect Widget | Trip Diary | Remote Operations
Car Dashboard | Share Car Location | Free Service Coupon Redemption
and many more...



OUTCLASS

EXPERIENCE



OUTCLASS COMFORT

The cabin is meticulously crafted to envelop you in comfort and tranquility. Plush seating combined with ample legroom and headroom, ensure that every journey is a relaxing one.

ERGONOMIC BUCKET SEATS



SPACIOUS REAR CABIN WITH ALL SEATS HEADREST



REAR AC VENTS



OUTCLASS STORAGE

A large boot, a roomy cabin and many conveniently placed spaces for storage give the new Honda Amaze room for more. More friends, more fun and more you.

FRONT CONSOLE CUP HOLDER



DOOR BOTTLE HOLDER (1 L EACH) WITH MAP POCKETS

LARGE BOOT SPACE (416 L)



REAR ARMREST WITH CUP HOLDER



SEAT BACK POCKET (CO-PASSENGER SIDE)

OUTCLASS CONVENIENCE

Convenience is always at your fingertips in the new Honda Amaze.
An array of convenient and useful features give you more ways to enjoy your car.

REMOTE START ENGINE



FIRST-IN-SEGMENT™

POWER ADJUSTABLE AND FOLD ORVM



FIRST-IN-SEGMENT™

WALK-AWAY AUTO LOCK



BRIGHT FRONT MAP LAMPS

OUTCLASS

PERFORMANCE



1.2 LITRES i-VTEC PETROL
ENGINE (E20 COMPLIANT)

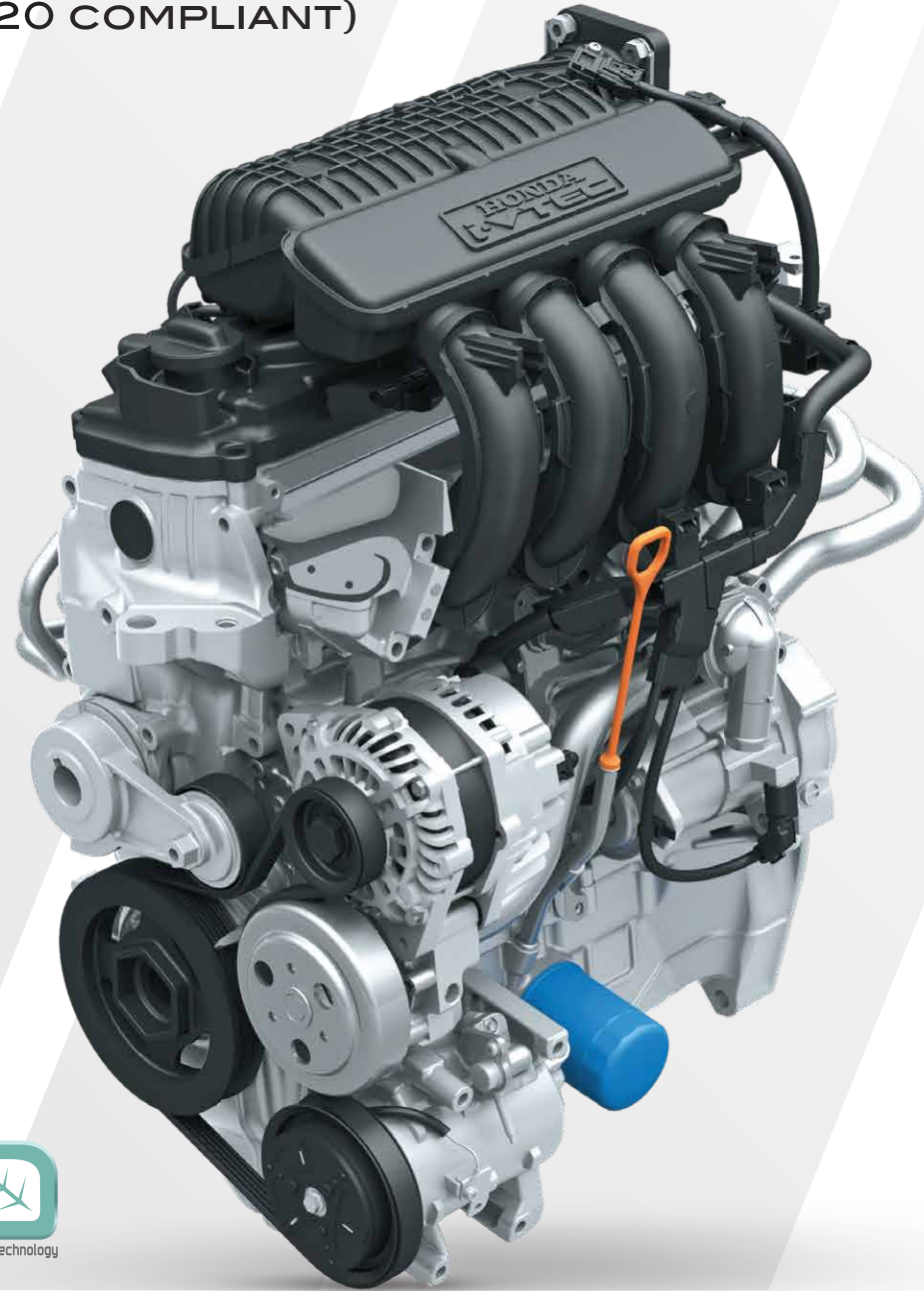

ENJOY THE TRUE PLEASURE OF DRIVING

Honda Amaze is powered by the iconic i-VTEC engine, delivering a performance that's both efficient and reliable. It offers the perfect balance of power and fuel economy so you can drive the car just as you intend to.

i-VTEC

BEST-IN-SEGMENT* POWER
66 kW [90 PS] @ 6000 RPM

MAX TORQUE
110 Nm @ 4800 RPM

4 CYLINDER
Powerful yet Efficient



PERFORMANCE

CVT – THE ULTIMATE AUTOMATIC



FUEL EFFICIENCY - 19.46 km/l[†]

THE CVT TRANSMISSION OFFERS EFFORTLESS GEAR TRANSITIONS DELIVERING A SMOOTH DRIVING EXPERIENCE.

5 SPEED MANUAL TRANSMISSION



FUEL EFFICIENCY - 18.65 km/l[†]



BEST-IN-SEGMENT[°]

SPORTY PADDLE SHIFTERS

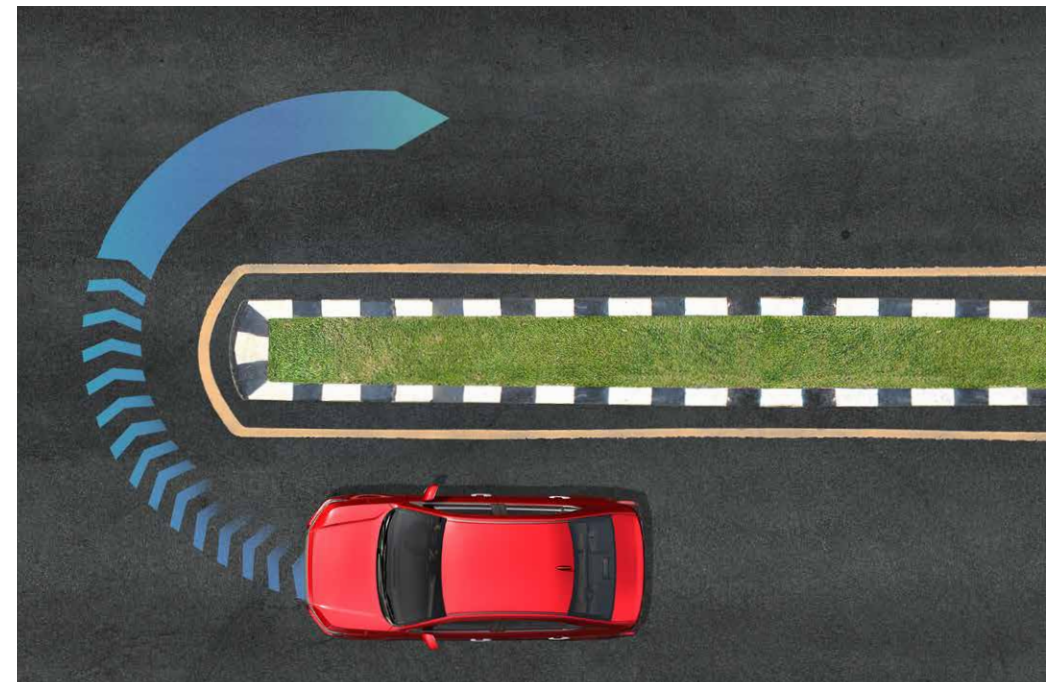

LOW TURNING RADIUS (4.7 M)

OUTCLASS

ACCESSORIES





FRONT GRILLE GARNISH



MAKE IT YOUR AMAZE WITH SIGNATURE PACKAGE

Style your Amaze, just the way you want. Choose from a wide range of accessories to create your own unique and personalized Honda Amaze.



TRUNK GARNISH

FOG LAMP GARNISH



WINDOW CHROME MOLDING



TAIL LAMP GARNISH



REAR BUMPER LOWER GARNISH



DOOR LOWER GARNISH



FRONT BUMPER GARNISH

i FOR COMPLETE ACCESSORIES REFER
ALL NEW AMAZE ACCESSORIES BROCHURE.

OUTCLASS ASSURANCE



Featuring one of the industry's most impressive warranty plans, the new Honda Amaze ensures you have assurance and peace of mind for a long, long time.

3 YEAR
UNLIMITED KILOMETERS
STANDARD WARRANTY*

UP TO
7 YEAR
UNLIMITED KILOMETERS
EXTENDED WARRANTY*

UP TO
10 YEAR
AND 1 20 000 KILOMETERS
ANYTIME WARRANTY*

*For details refer to Owner's Manual, Warranty Booklet or Extended Warranty Document. †10 year Anytime Warranty is extendable up to the maximum age of 10 years/1 20 000 kilometres by renewing every year and is applicable from the date of purchase of car.

SPECIFICATIONS

Engine	Type	Water Cooled Inline 4 Cylinder i-VTEC SOHC
	Displacement (cm ³)	1 199
	No. of Valves	16
	Power (kW [PS] @ rpm)	66 [90] @ 6 000
	Torque (Nm @ rpm)	110 @ 4 800
	Fuel Efficiency* (km/l)	19.46 (CVT), 18.65 (MT)
	Fuel Type	Compliant with E20 (20% ethanol blended) Petrol
Transmission	Automatic	CVT (Continuously Variable Transmission)
	Manual	5 Forward & 1 Reverse
Dimensions & Weight	Overall Length (mm)	3 995
	Overall Width (mm)	1 733
	Overall Height (mm)	1 500
	Wheelbase (mm)	2 470
	Front Track (mm)	1 490 (V), 1 493 (VX, ZX)
	Rear Track (mm)	1 487 (V), 1 488 (VX, ZX)
	Kerb Weight (kg)	952 - 986
	Max. GVW (kg)	1 360 (MT), 1 380 (CVT)
	Fuel Tank Capacity (Litres)	35
	Seating Capacity (Persons)	5
	Boot Space (Litres)	416
	Steering System	Electric Power Assisted
	Turning Circle Radius (m)	4.7 (V), 4.9 (VX, ZX)
Suspension System	Front	McPherson Strut with Coil Spring
	Rear	Torsion beam with Coil Spring
	Anti-Roll Bar	Torsion Bar Type
	Shock Absorbers	Telescopic Hydraulic Nitrogen Gas-filled
Brake System	Front	Ventilated Disc
	Rear	Drum
	Parking	Hand-brake, Mechanically activating on Rear Wheels
Tyres & Wheels	Wheel Type	14x5J Steel (V), 15x5 1/2J Alloy (VX, ZX)
	Tyre Type & Size	Tubeless Radial 175/65 R14 82T (V), 185/60 R15 84H (VX, ZX)
	Spare Wheel Type	Steel Wheel

The spare wheel does not come with Alloy Wheel and the rim / tyre size may differ from the standard size depending on the variant.

V refers to AMAZE 3RD GEN V MT/CVT (i-VTEC), VX refers to AMAZE 3RD GEN VX MT/CVT (i-VTEC), ZX refers to AMAZE 3RD GEN ZX MT/CVT (i-VTEC)



GRADE

V (MAIN FEATURES)

Safety & Security

Advanced Compatibility Engineering (ACE™) Body Structure
6 Airbags System (Dual Front i-SRS, Front Seats i-Side & Side Curtain)
Energy Absorbing Front Pretensioner Seatbelts with Load Limiter
3 point Emergency Locking retractor (ELR) Seatbelts (x5)
Front & Rear Seats Head Restraints (x5)
ISOFIX compatible Rear Side Seats with Lower Anchorage & Top Tether
Rear Parking Sensors
Anti-Lock Brake System (ABS) with Electronic Brake-force Distribution (EBD)
Brake Assist (BA)
Brake Override System
Vehicle Stability Assist (VSA) with Electronic Stability & Traction Control
Hill Start Assist
Emergency Stop Signal
Day/Night Inside Rear View Mirror
Seatbelt Indicator & Reminder (5 seats)
Speed Alarm Indicator & Reminder
Door Ajar Information & Alarm
Vehicle Immobilizer
Dual Horn
Battery Sensor

Exterior Design

Integrated LED Daytime Running Lights (DRLs), Position Lamps & Turn Indicators
LED Projector Headlamps
Headlamp Inner Lens Cover Gloss Black
Iconic Wing Shaped LED Tail Lamps

Signature Chequered Flag Pattern Grille with Chrome Upper Moulding
R14 Steel Wheels with Trim Cover
Shark Fin Antenna
Body Coloured Door Mirrors
Integrated LED Side Turn Indicator on Door Mirrors
Black Sash Tape on B-Pillar

Connectivity & Infotainment

Advanced Touchscreen Display Audio
20.3 cm (8") Advanced HD Touchscreen Display Audio
IPS Display
Wired Smartphone Connectivity (Android Auto, Apple CarPlay, Weblink)
Wireless Smartphone Connectivity (Android Auto, Apple CarPlay)
Voice Command Support for Smartphone Connectivity
AM/FM Digital Radio Tuner, MP3/WAV, i-Pod®/i-Phone®
Bluetooth® for Hands Free Telephony & Audio Streaming support
Remote Control by Smartphone Application via Bluetooth®
USB-In Ports x1
Premium Surround Sound System (4 Speakers)
Steering Mounted Audio & Hands-Free Telephone Illuminated Switches
Steering Mounted Voice Recognition Switch with Illumination

Interior Design and Colour, Materials, Finish

Premium Beige & Black Two-Tone Colour Coordinated Interiors
Premium Embossed Fabric Upholstery
Piano Black Garnish on Steering Wheel
Front AC Vents Knob Silver Paint
Trunk Lid Inside Lining Cover



V (MAIN FEATURES)

Comfort & Convenience

Power Central Door Lock with Keyless Entry
Driver Master Door Lock Switch with Inner Handle 1- Motion Unlock
Automatic Door Locking & Unlock
Electrical Trunk Lock with Keyless Release
Follow-Me-Home / Lead-Me-To-Car Headlights (Auto Off Timer)
Power Windows (Front & Rear)
Driver Power Window Auto-Open/Close Function with Pinch Guard
Power Window Key-off Operation (until 10 mins or Front Door Open)
Power Adjustable Door Mirrors
Manual Air Conditioner with Heater
PM2.5 Cabin Air Purifying Dust & Pollen Filter
Tilt Steering Column Adjustment for Height
Driver Seat Height Adjuster
7-Speed Paddle Shifters (CVT Only)
Select Lever Shift Illumination (CVT Only)
Select Lever Shift Lock Release Slot (CVT Only)
One Touch Turn Signal for Lane Change Signaling
Accessory Charging Ports with Lid (Front Console x1 + Rear x1)
Floor Console Cupholders & Utility Storage Space
Front Console Lower Pocket for Smartphones
Rear Center Foldable Armrest with Cupholder
1L Bottle Holders in All Doors
Driver Sunvisor Vanity Mirror with Lid
Assistant Sunvisor Vanity Mirror with Lid

Interior Roof Light

Foldable Grab Handles (Soft Closing Type)

Cargo Area Illumination Light

Instrumentation

Digital-Analogue Integrated Meter with 17.7 cm (7 inch) HD Full Colour TFT MID

Multi Function Driver Information Interface

Digital Speedometer

Range & Fuel Economy Information

Average Speed & Time Information

G-Meter Display

Display Contents & Vehicle Settings Customization

Vehicle Information & Warning Message Display

Rear Parking Sensor Proximity Display

Rear Seat Reminder

Steering Scroll Selector Wheel and Meter Control Switch

Illumination Control Switch

7-speed Manual Shift Mode & Position Indicator (CVT Only)

Fuel Gauge Display with Fuel Reminder Warning

Trip Meter (x2)

Average Fuel Economy Information

Instant Fuel Economy Information

Cruising Range (Distance-to-Empty) Information

Other Warning Lamps & Information



VX (OVER V)

Safety & Security

- LaneWatch™ Camera
- Multi-Angle Rear Camera with Guidelines (Normal, Wide, Top-Down Modes)
- Automatic Headlight Control with Light Sensor
- Headlight Integration with Wipers
- Rear Windshield Demister
- Security System Alarm

Exterior Design

- Headlamp Inner Lens Cover Aluminized
- LED Projector Front Fog Lamps
- Multi-Spoke R15 Premium Silver Alloy Wheels
- Front & Rear Mud Guards

Connectivity & Infotainment

- Next Gen Honda Connect with Telematics Control Unit (TCU)
- Alexa Remote Capability
- Smartwatch Connectivity
- USB-In Ports x2
- Premium Surround Sound System (4 Speakers + 2 Tweeters)

Interior Design and Colour, Materials, Finish

- Satin Metallic Garnish on Dashboard
- Inside Door Handle Metallic Finish

Comfort & Convenience

- Honda Smart Key System with Keyless Remote (x2)
- One-Push Start/Stop Button
- Touch-Sensor Based Smart Keyless Access
- Remote Engine Start (CVT Only)
- Walk Away Auto Lock (Customizable)
- Power Folding Door Mirrors
- Fully Automatic Climate Control with MAX COOL mode
- Rear Air Conditioning Vents
- Wireless Smartphone Charger
- Assistant Seat Back Pockets
- Front Map Light

Instrumentation

- Outside Temperature Information



ZX (OVER VX)

Safety & Security

Honda SENSING (ADAS*)
Collision Mitigation Braking System (CMBS)
Adaptive Cruise Control
Lane Keeping Assist System (LKAS)
Lead Car Departure Notification System
Road Departure Mitigation System
Auto High-Beam

Exterior Design

Front Grille Mesh Gloss Black Painting Type
Dual-Tone Diamond-Cut Multi-Spoke R15 Sporty Alloy Wheels
Outer Door Handles Chrome Finish

Interior Design and Colour, Materials, Finish

Satin Metallic Garnish on Steering Wheel
Soft Touch Front Door Lining Armrest Fabric Pad

Comfort & Convenience

Adaptive Cruise Control & LKAS Operation Switches on Steering Wheel

Instrumentation

Safety Support Settings in Multi Function Driver Information Interface



FEATURES

SAFETY AND SECURITY

	V	VX	ZX
Honda SENSING (ADAS*)	-	-	○
-Collision Mitigation Braking System (CMBS)	-	-	○
-Adaptive Cruise Control	-	-	○
-Lane Keeping Assist System (LKAS)	-	-	○
-Lead Car Departure Notification System	-	-	○
-Road Departure Mitigation System	-	-	○
-Auto High-Beam	-	-	○
Advanced Compatibility Engineering (ACE™) Body Structure	○	○	○
6 Airbags System (Dual Front i-SRS, Front Seats i-Side & Side Curtain)	○	○	○
Energy Absorbing Front Pretensioner Seatbelts with Load Limiter	○	○	○
3 point Emergency Locking retractor (ELR) Seatbelts (x5)	○	○	○
Front & Rear Seats Head Restraints (x5)	○	○	○
ISOFIX compatible Rear Side Seats with Lower Anchorage & Top Tether	○	○	○
LaneWatch™ Camera	-	○	○
Multi-Angle Rear Camera with Guidelines (Normal, Wide, Top-Down Modes)	-	○	○
Rear Parking Sensors	○	○	○
Anti-Lock Brake System (ABS) with Electronic Brake-force Distribution (EBD)	○	○	○
Brake Assist (BA)	○	○	○
Brake Override System	○	○	○
Vehicle Stability Assist (VSA) with Electronic Stability & Traction Control	○	○	○
Hill Start Assist	○	○	○
Emergency Stop Signal	○	○	○
Automatic Headlight Control with Light Sensor	-	○	○
Day/Night Inside Rear View Mirror	○	○	○
Headlight Integration with Wipers	-	○	○
Rear Windshield Demister	-	○	○
Seatbelt Indicator & Reminder (5 seats)	○	○	○
Speed Alarm Indicator & Reminder	○	○	○
Door Ajar Information & Alarm	○	○	○
Vehicle Immobilizer	○	○	○
Security System Alarm	-	○	○
Dual Horn	○	○	○
Battery Sensor	○	○	○



EXTERIOR DESIGN

	V	VX	ZX
Integrated LED Daytime Running Lights (DRLs), Position Lamps & Turn Indicators	○	○	○
LED Projector Headlamps	○	○	○
Headlamp Inner Lens Cover Colour	Gloss Black	Aluminized	Aluminized
LED Projector Front Fog Lamps	-	○	○
Iconic Wing Shaped LED Tail Lamps	○	○	○
Signature Chequered Flag Pattern Grille with Chrome Upper Moulding	○	○	○
Front Grille Mesh Gloss Black Painting Type	-	-	○
R14 Steel Wheels with Trim Cover	○	-	-
Multi-Spoke R15 Premium Silver Alloy Wheels	-	○	-
Dual-Tone Diamond-Cut Multi-Spoke R15 Sporty Alloy Wheels	-	-	○
Outer Door Handles Chrome Finish	-	-	○
Shark Fin Antenna	○	○	○
Body Coloured Door Mirrors	○	○	○
Integrated LED Side Turn Indicator on Door Mirrors	○	○	○
Front & Rear Mud Guards	-	○	○
Black Sash Tape on B-Pillar	○	○	○

CONNECTIVITY & INFOTAINMENT

Next Gen Honda Connect with Telematics Control Unit (TCU)	-	○	○
-Alexa Remote Capability	-	○	○
-Smartwatch Connectivity	-	○	○
Advanced Touchscreen Display Audio	○	○	○
-20.3 cm (8") Advanced HD Touchscreen Display Audio	○	○	○
-IPS Display	○	○	○
-Wired Smartphone Connectivity (Android Auto, Apple CarPlay, Weblink)	○	○	○
-Wireless Smartphone Connectivity (Android Auto, Apple CarPlay)	○	○	○
-Voice Command Support for Smartphone Connectivity	○	○	○
-AM/FM Digital Radio Tuner, MP3/WAV, iPod®/iPhone®	○	○	○
-Bluetooth® for Hands Free Telephony & Audio Streaming support	○	○	○
-Remote Control by Smartphone Application via Bluetooth®	○	○	○
USB-In Ports	1	2	2
Premium Surround Sound System (Speakers + Tweeters)	4	6 (4+2)	6 (4+2)
Steering Mounted Audio & Hands-Free Telephone Illuminated Switches	○	○	○
Steering Mounted Voice Recognition Switch with Illumination	○	○	○



	V	VX	ZX
INTERIOR DESIGN AND COLOUR, MATERIALS, FINISH			
Premium Beige & Black Two-Tone Colour Coordinated Interiors	○	○	○
Premium Embossed Fabric Upholstery	○	○	○
Piano Black Garnish on Steering Wheel	○	○	-
Satin Metallic Garnish on Steering Wheel	-	-	○
Soft Touch Front Door Lining Armrest Fabric Pad	-	-	○
Satin Metallic Garnish on Dashboard	-	○	○
Inside Door Handle Metallic Finish	-	○	○
Front AC Vents Knob Silver Paint	○	○	○
Trunk Lid Inside Lining Cover	○	○	○
COMFORT & CONVENIENCE			
Power Central Door Lock with Keyless Entry	○	○	○
Driver Master Door Lock Switch with Inner Handle 1-Motion Unlock	○	○	○
Automatic Door Locking & Unlock	○	○	○
Honda Smart Key System with Keyless Remote (x2)	-	○	○
-One-Push Start/Stop Button	-	○	○
-Touch-Sensor Based Smart Keyless Access	-	○	○
-Remote Engine Start (CVT Only)	-	○	○
-Walk Away Auto Lock (Customizable)	-	○	○
-Electrical Trunk Lock with Keyless Release	○	○	○
Follow-Me-Home / Lead-Me-To-Car Headlights (Auto Off Timer)	○	○	○
Power Windows (Front & Rear)	○	○	○
Driver Power Window Auto-Open/Close Function with Pinch Guard	○	○	○
Power Window Key-off Operation (until 10 mins or Front Door Open)	○	○	○
Power Folding Door Mirrors	-	○	○
Power Adjustable Door Mirrors	○	○	○
Manual Air Conditioner with Heater	○	-	-
Fully Automatic Climate Control with MAX COOL mode	-	○	○
Rear Air Conditioning Vents	-	○	○
PM2.5 Cabin Air Purifying Dust & Pollen Filter	○	○	○
Tilt Steering Column Adjustment for Height	○	○	○
Driver Seat Height Adjuster	○	○	○
Adaptive Cruise Control & LKAS Operation Switches on Steering Wheel	-	-	○



COMFORT & CONVENIENCE

	V	VX	ZX
7-Speed Paddle Shifters (CVT Only)	○	○	○
Select Lever Shift Illumination (CVT Only)	○	○	○
Select Lever Shift Lock Release Slot (CVT Only)	○	○	○
One Touch Turn Signal for Lane Change Signaling	○	○	○
Accessory Charging Ports with Lid (Front Console x1 + Rear x1)	○	○	○
Floor Console Cupholders & Utility Storage Space	○	○	○
Front Console Lower Pocket for Smartphones	○	○	○
Wireless Smartphone Charger	-	○	○
Rear Center Foldable Armrest with Cupholder	○	○	○
1L Bottle Holders in All Doors	○	○	○
Assistant Seat Back Pockets	-	○	○
Driver Sunvisor Vanity Mirror with Lid	○	○	○
Assistant Sunvisor Vanity Mirror with Lid	○	○	○
Front Map Light	-	○	○
Interior Roof Light	○	○	○
Cargo Area Illumination Light	-	○	○
Foldable Grab Handles (Soft Closing Type)	○	○	○

INSTRUMENTATION

Digital-Analogue Integrated Meter with 17.7 cm (7 inch) HD Full Colour TFT MID	○	○	○
Multi Function Driver Information Interface	○	○	○
-Digital Speedometer	○	○	○
-Range & Fuel Economy Information	○	○	○
-Average Speed & Time Information	○	○	○
-G-Meter Display	○	○	○
-Display Contents & Vehicle Settings Customization	○	○	○
-Safety Support Settings	-	-	○
-Vehicle Information & Warning Message Display	○	○	○
-Rear Parking Sensor Proximity Display	○	○	○
-Rear Seat Reminder	○	○	○
-Steering Scroll Selector Wheel and Meter Control Switch	○	○	○



INSTRUMENTATION

	V	VX	ZX
Illumination Control Switch	<input type="radio"/>	<input type="radio"/>	<input type="radio"/>
7-speed Manual Shift Mode & Position Indicator (CVT Only)	<input type="radio"/>	<input type="radio"/>	<input type="radio"/>
Fuel Gauge Display with Fuel Reminder Warning	<input type="radio"/>	<input type="radio"/>	<input type="radio"/>
Trip Meter (x2)	<input type="radio"/>	<input type="radio"/>	<input type="radio"/>
Average Fuel Economy Information	<input type="radio"/>	<input type="radio"/>	<input type="radio"/>
Instant Fuel Economy Information	<input type="radio"/>	<input type="radio"/>	<input type="radio"/>
Cruising Range (Distance-to-Empty) Information	<input type="radio"/>	<input type="radio"/>	<input type="radio"/>
Outside Temperature Information	-	<input type="radio"/>	<input type="radio"/>
Other Warning Lamps & Information	<input type="radio"/>	<input type="radio"/>	<input type="radio"/>



Scan now to Book or Buy
Honda From Home



Terms and conditions applicable. The Images and depictions shown in this brochure are computer generated/ enhanced for illustrative and representational purposes only. Actual colour, feature and any other specification as shown may not be part of standard fitment and may differ from actual product. Appearance of black shade on glass of vehicle is due to lighting effect. All colours, features and specifications are grade specific and subject to change without prior notice. Please check and experience the availability of variants, colours and features at the authorized dealerships. Accessories shown may not be part of standard equipment and need to be purchased separately. *Honda SENSING is Honda's exclusive Advanced Driver Assistance System (ADAS). Honda SENSING cannot substitute human acumen and vigilance while driving. Honda Cars India Limited urges drivers to follow traffic rules which are meant to keep them safe on roads. †Fuel efficiency as certified by ICAT under rule 115 of CMVR 1989. Fuel efficiency figures are based on standard test conditions. Rounded off to two decimal places. Actual fuel efficiency may vary based on road conditions, driving technique, and driving environment. ‡Segment to be defined as sedans less than the length of 4000 mm. For more information, please visit our authorized dealership or www.hondacarindia.com. Honda Cars India Limited urges drivers to follow traffic rules which are meant to keep them safe on roads. For corporate sales enquiry please write to corporatesales@hondacarindia.com.



