

XEV 9e



ELECTRIC ORIGIN  
SUVs

mahindra

# EXPERIENCE SUAVE INTELLIGENCE.



For those who move with bold confidence, the go-getters, the self-assured, the ones who redefine success on their own terms. The XEV 9e is an extension of your discerning taste, an embodiment of minimal sophistication and elegance in motion.



Car seen is the Mahindra XEV 9e in Tango Red

# REMEMBER TO BREATHE

The ultimate expression of sophistication and performance, offering a suave SUV coupé design that seamlessly blends luxury with boldness.



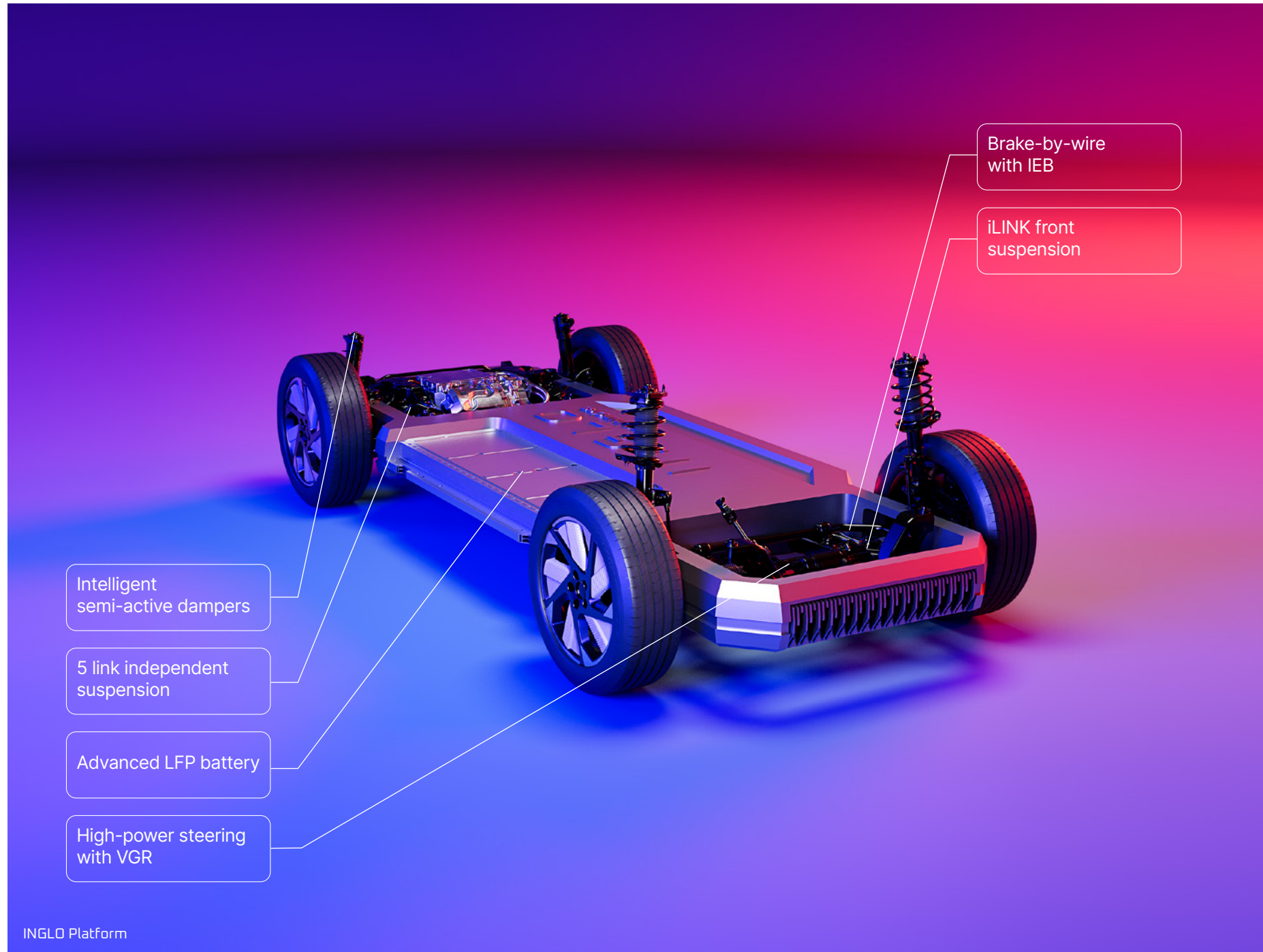

# INGLO – ELECTRIC ORIGIN ARCHITECTURE

Benchmark in innovation with 152 patents\*  
and 45 design registrations\*



Combining indomitable Indian spirit with global standards and ambition, this unique architecture is as adaptable as it is innovative. A universe of advanced components integrated seamlessly to deliver exceptional range, power, handling.

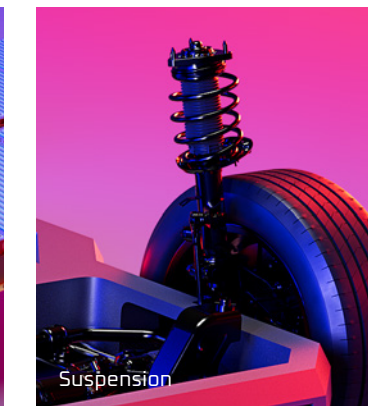
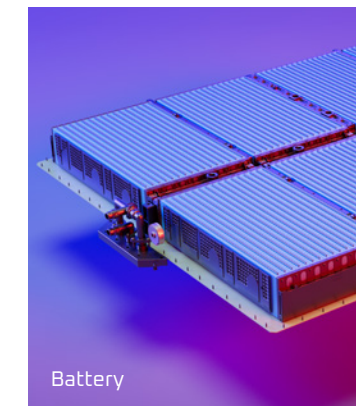
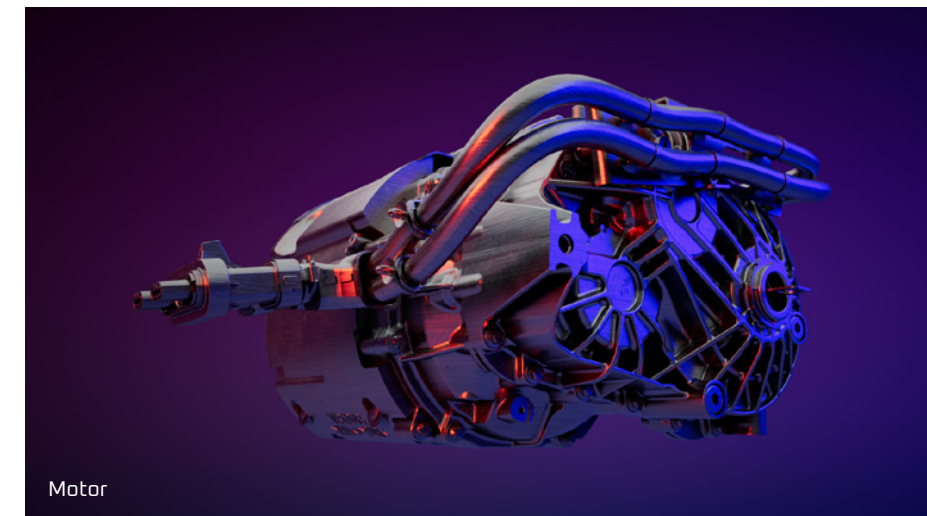
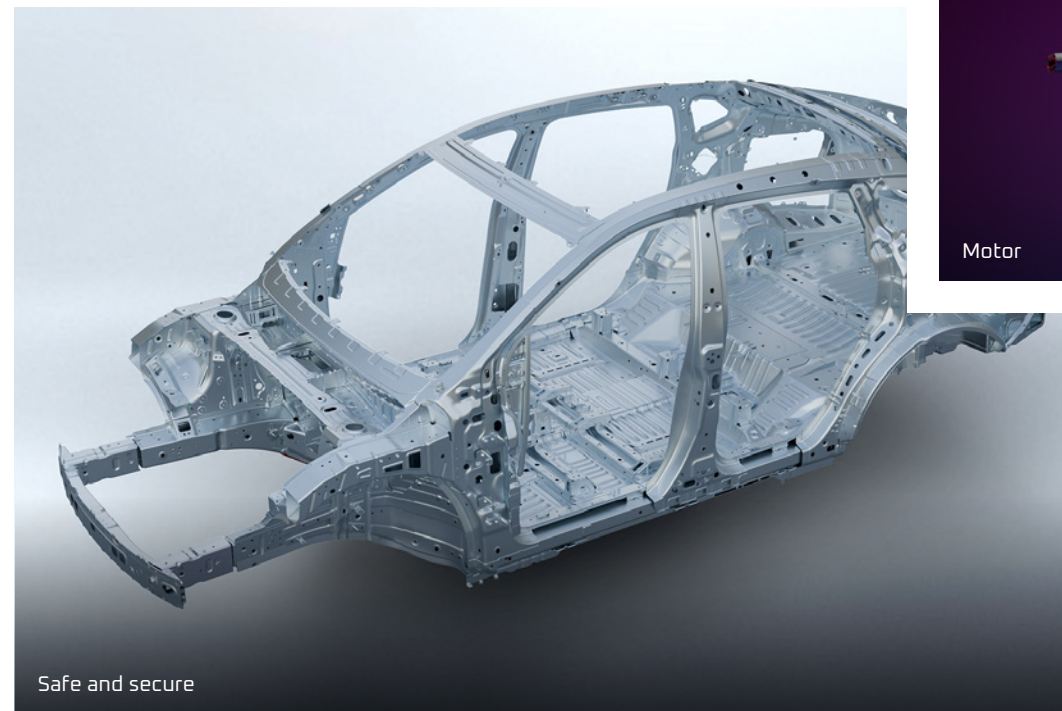

\*Patents and design registrations applied

# SAFETY IS IN OUR DNA

Seven airbags with reinforced BIW structure

FRONTAL CRASH PROTECTION

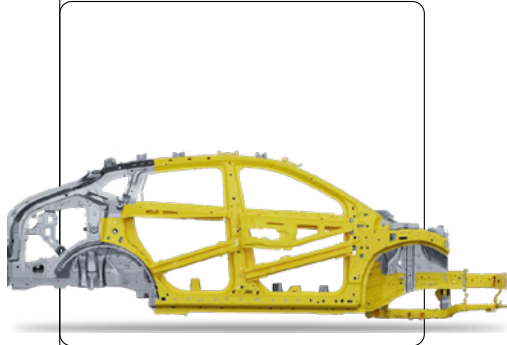

30g peak deceleration

400 kJ impact energy

SIDE CRASH PROTECTION

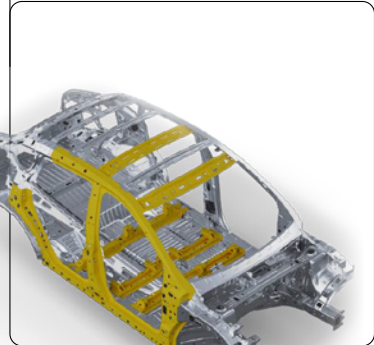

7 AIRBAGS



Car seen is the Mahindra XEV 9e in Tango Red

# BATTERY ROBUSTNESS

Extensive testing	14,577 HOURS	55+ LAKH KM
-------------------	--------------	-------------

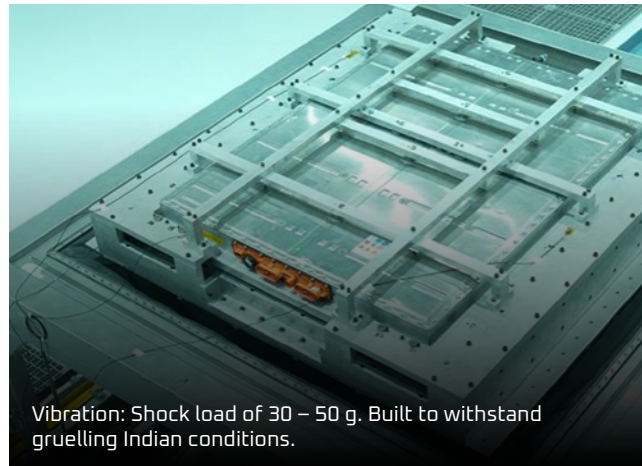
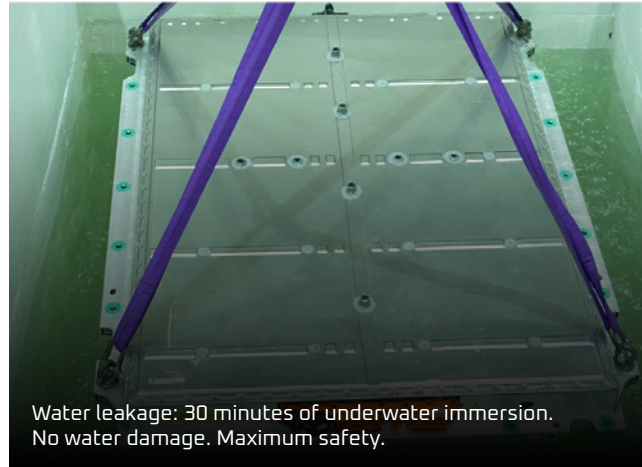



Car seen is the Mahindra XEV 9e in Tango Red

# 656 KM RANGE IN A SINGLE CHARGE\*

500+ km real-world range in metro driving conditions with AC on (79 kWh battery).

Vehicle	Battery capacity	MIDC – P1 + P2 (ARAI certification)
XEV 9e	79 kWh	656 kWh
	59 kWh	542 kWh

**500+ km real-world range ensures you only need to charge once a week\*\***

Bengaluru 508	Jaipur 491	Trivandrum 518
Coimbatore 559	Chandigarh 539	Krochi 499
Chennai 529	Delhi 515	Mysore 501
Hyderabad 504	Kolkata 546	Mangalore 499
Pune 503	Bhubaneshwar 527	Goa 553
Ahmedabad 497	Vizag 517	Mumbai 497
Udaipur 529	Rajahmundry 540	Nashik 512

\* As per MIDC P1 + P2 certification - with the 79 kWh battery pack.

\*\* As per tests conducted internally with moderate ambient temperature, low HVAC usage, and optimal drive mode.

# UNMATCHED PERFORMANCE

Refinement is the XEV 9e's essence. Every detail, every angle, every surface is crafted to captivate. Designed to take your breath away and engineered for absolute control, it delivers a driving experience defined by elegance, power, and precision. Perfection, made effortless.

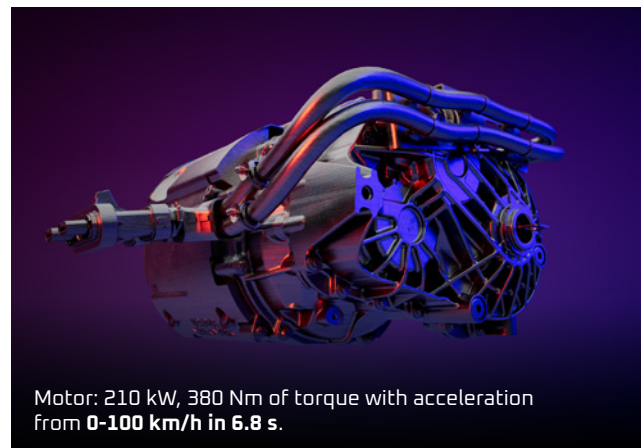

Motor: 210 kW, 380 Nm of torque with acceleration from 0-100 km/h in 6.8 s.



Intelligent Adaptive Suspension: 15 ms of real-time control of damping force.



Turning radius: 10 m turning circle diameter and best maneuverability.

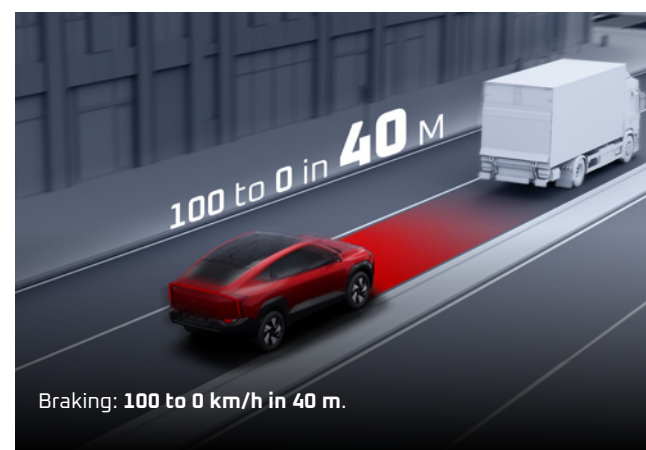

Braking: 100 to 0 km/h in 40 m.



Interior seen is the XEV 9e





Car seen is the Mahindra XEV 9e in Tango Red

# BEST-IN-CLASS CABIN SPACE

The XEV 9e is engineered for maximum comfort and convenience. Stretch out, relax, and embrace the freedom of limitless ease.



Spacious frunk: 150 L



Gesture controlled power tailgate



Expansive cabin space: 1617 L



Boot space: 663 L

# STAY COOL, CALM AND PROTECTED

99.5%\* UV ray filtration, a whisper-quiet cabin and, best-in-class air conditioning – all in one world-class eSUV



**Best-in-class air conditioning:** The XEV 9e is equipped with a super-fast air conditioning system that has 95% PM 2.5 filtration efficiency with a VR-led smart air purifier



**Whisper-quiet cabin:** Enjoy uninterrupted conversations in the XEV 9e, even at speeds of up to 130 km/h

The performance figures, specifications, and features mentioned in this brochure, including but not limited to speed, fuel efficiency, acceleration, and other technical details, have been tested and recorded under controlled conditions and may vary depending on driving conditions, vehicle load, maintenance, and other factors. Actual performance may differ from the values mentioned due to real-world variables.

\*Unmatched UV protection: Maximum filtration of UV rays that blocks 99.5% UV rays (200 – 400 nm)



Interior seen is the XEV 9e



Interior seen is the XEV 9e

# THE FASTEST MIND IN THE AUTOMOTIVE WORLD

MAIA, inspired by the Sanskrit name for "Magic", is designed to assist you with your everyday needs.

**4 HPC CHIPS**

Enable high performance computing for a safe and enhanced driving experience

**12 SENSORS  
5 RADARS**

Ensure a safe driving experience with Level 2+ Advanced Driver Assist Systems technology

**ZONAL ARCHITECTURE**

Allows for OTA updates of features and technology

**51 TOPS  
75 MLOC**

51 trillion operations per second, real-time responses, advanced safety and driver assistance

**24 GB RAM**

Lightning-fast performance, enabled to handle multiple tasks

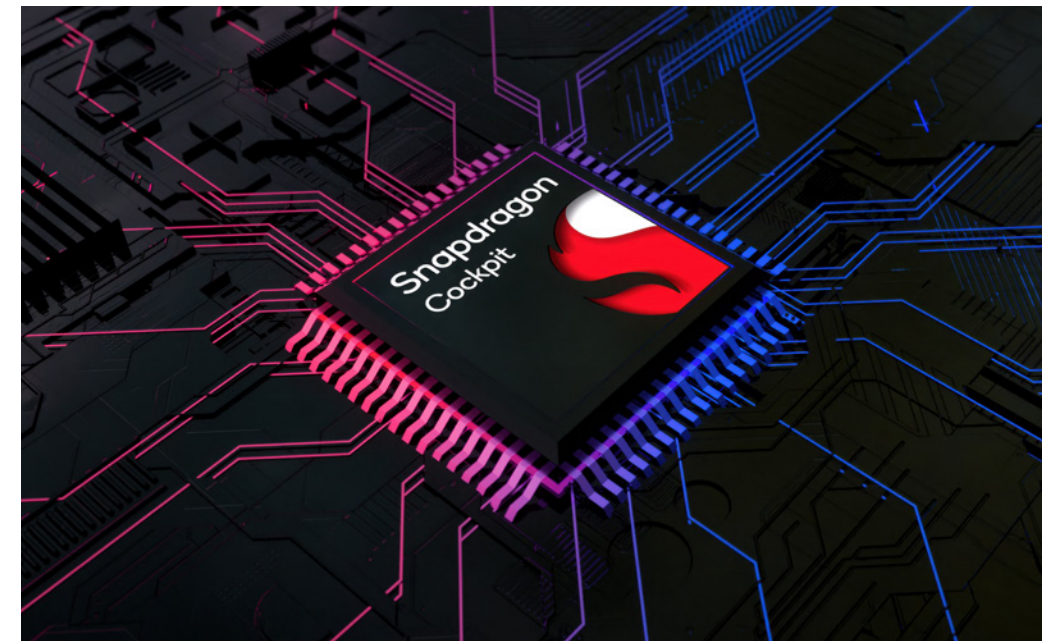

# THE ADVANCED SOFTWARE ARCHITECTURE OF MAIA



MAIA is the neural network – the brain – of our eSUVs. Derived from the Sanskrit word for magic, MAIA conjures incredible power from AI and high-performance computing to deliver an unmatched driving experience. At its heart is the Qualcomm Snapdragon 8295 chipset, a technological marvel built on a 5 nm process node, achieving 200K DMIPS, 46 TOPS, and 3000 GFLOPS. This powerhouse effortlessly handles billions of commands and complex tasks in real time, ensuring instant responsiveness, fluid performance, and intelligence that anticipates all your needs.

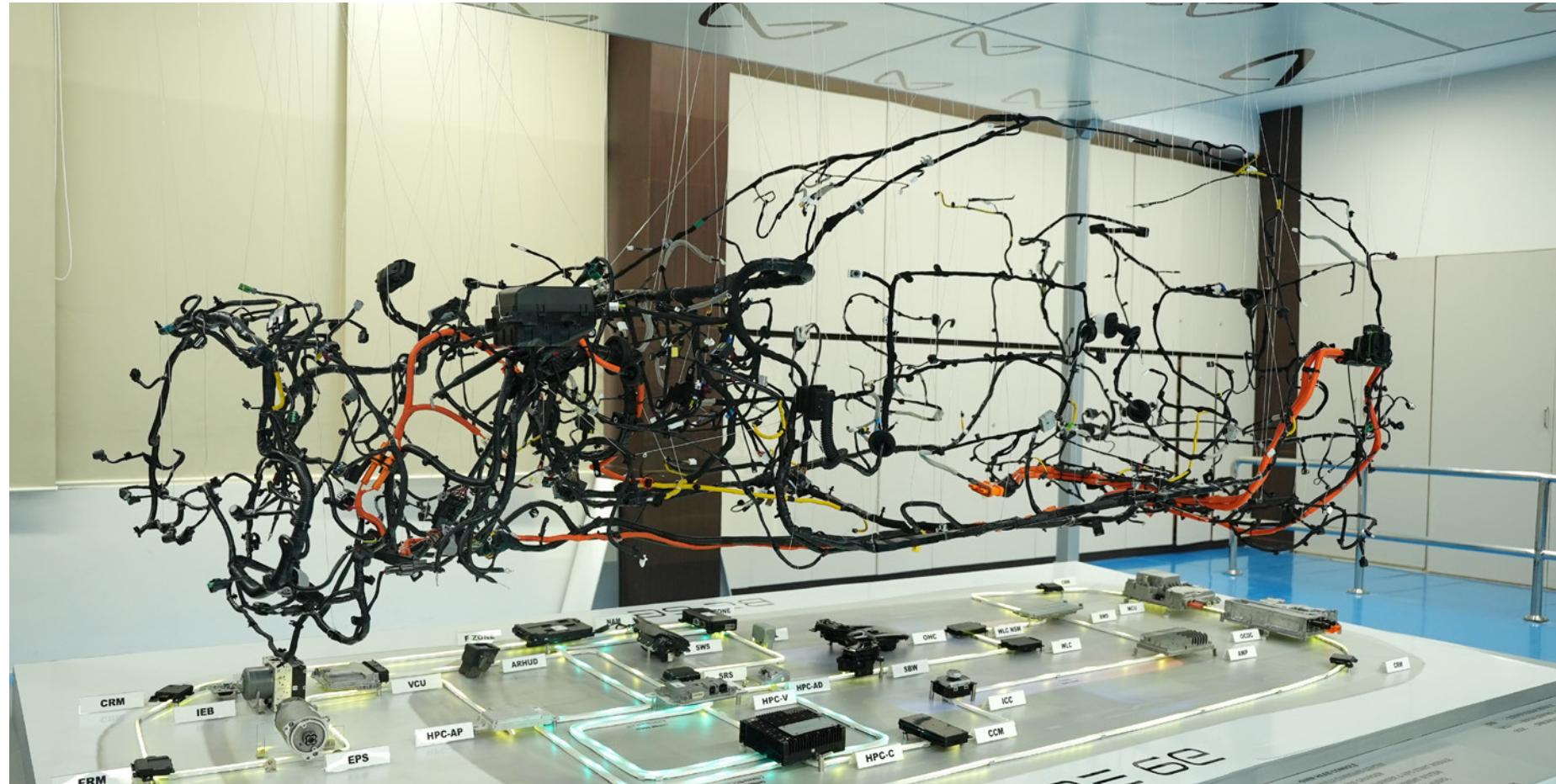

# MAIA – THE FASTEST MIND IN THE MOBILE WORLD



Processor	MAIA	Luxury phone
CPU	220K DMIPS	110K DMIPS
GPU	3100 GFLOPS	2227 GFLOPS
NPU	51 TOPS	35 TOPS



Entertainment

# WIDE CINEMASCOPE, THREE-SCREEN, HIGH- DEFINITION DISPLAY

The XEV 9e redefines sophistication with a cockpit that seamlessly blends elegance and technology. A triple-screen layout caters to both driver and front passenger, creating an environment that is as refined as it is functional. The two-spoke steering wheel, with touch-operated buttons and a subtle illuminating effect, remains understated when off and comes alive when you're ready to drive. Comfortable, beautifully padded front seats and a spacious, elevated cabin envelop you in striking luxury. Designed for control, crafted for comfort. The XEV 9e's cockpit is where refinement meets innovation.



VisionX



Interior seen is the XEV 9e

# LIVE IN FULL COLOUR

## Live Your Mood

Three immersive modes that transport you to a different world, depending on your mood. Calm Mode helps you find some peace, whenever you seek it. Leave stress behind and embrace tranquillity. Experience the ultimate in comfort and relaxation with Cozy Mode – your personal haven on wheels. Club Mode transforms your eSUV into a concert on wheels. Club Mode, making every journey unforgettable. Your eSUV. Your club.



Live Your Mood

## LightMeUp + Infinity Roof

16 million hues in the sky, all yours with the Infinity Roof. Indulge in panoramic vistas and customise your ambience with our sophisticated ambient lighting system.



Infinity Roof



LightMeUp  
Interior seen is the XEV 9e

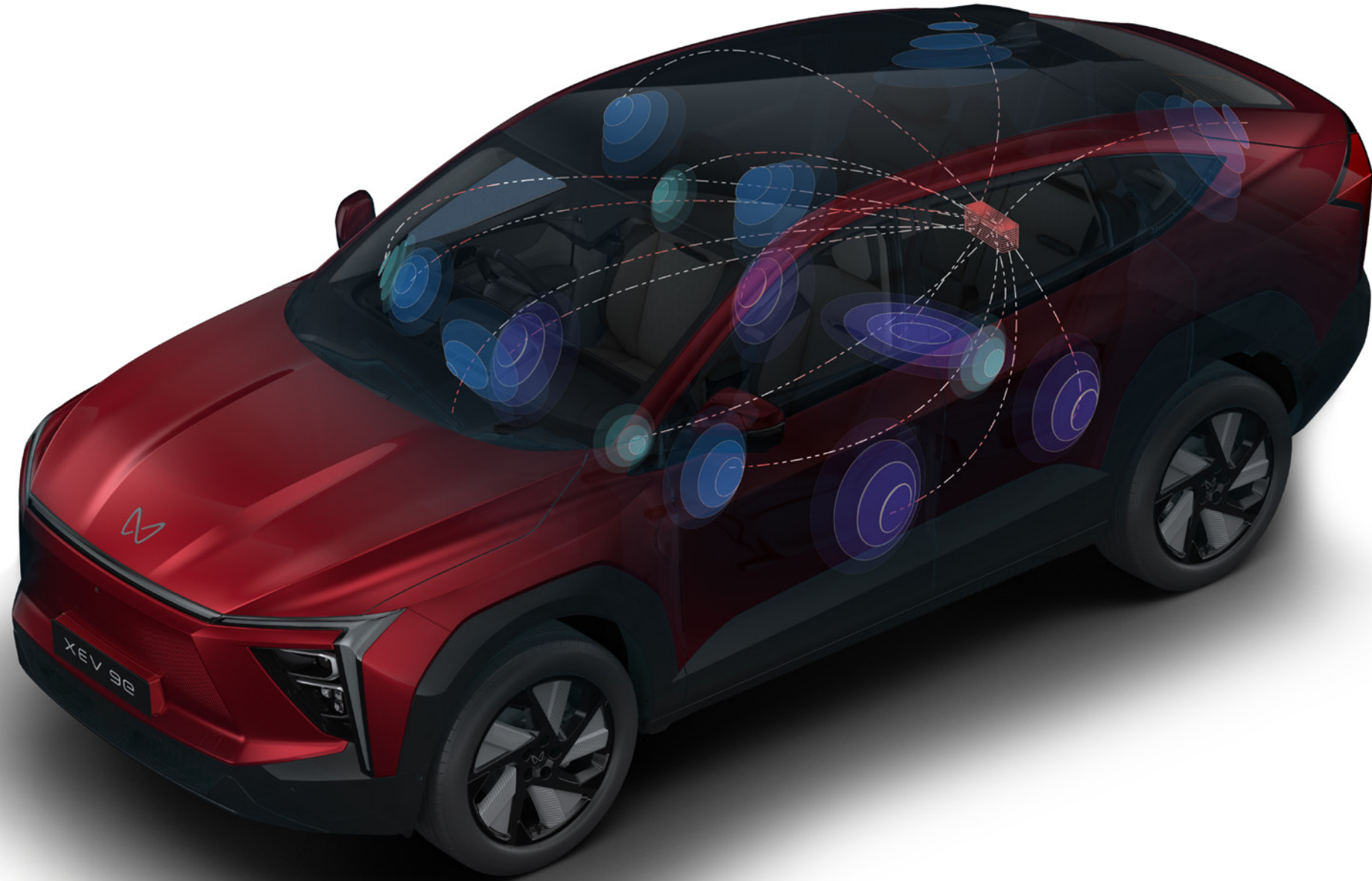

- Mid Range Speakers
- Tweeters
- Woofers / Subwoofer
- Amplifier

Car seen is the Mahindra XEV 9e in Tango Red

# 1400 WATT, 16-SPEAKER HARMAN KARDON WITH DOLBY ATMOS

## Mahindra Sonic Studio

Hear every note, feel every beat. The 16-speaker Harman Kardon sound system with Dolby Atmos surrounds you with crystal-clear audio, making every drive feel like a concert.



Interior seen is the XEV 9e

# AUTOPARK\* – PARKING MADE EFFORTLESS

AutoPark takes the wheel, so you don't have to break a sweat.

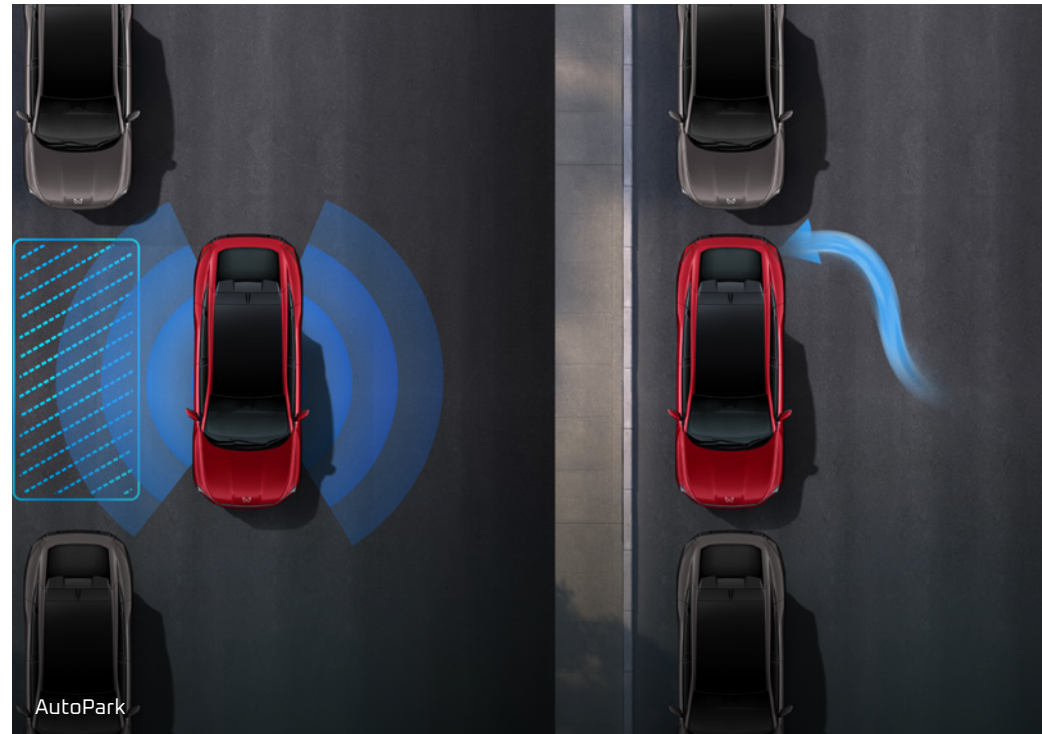

\*As per applicable terms & conditions

# FROM ECO TO EGO

Choose your driving style with modes that adapt to road conditions and your performance parameters.

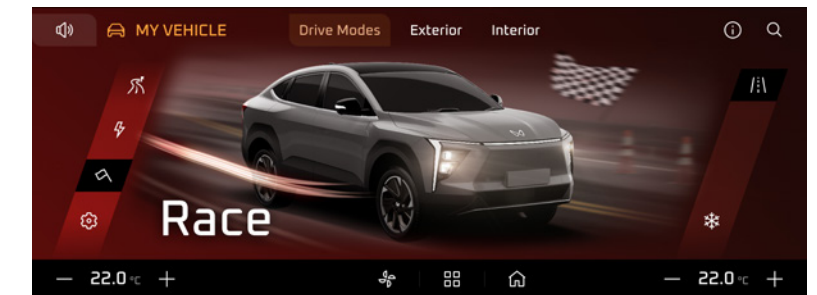
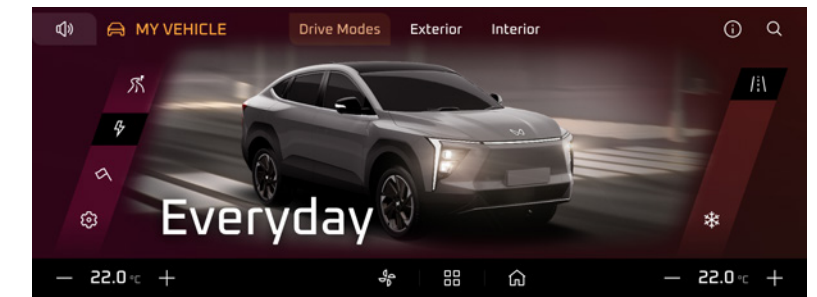
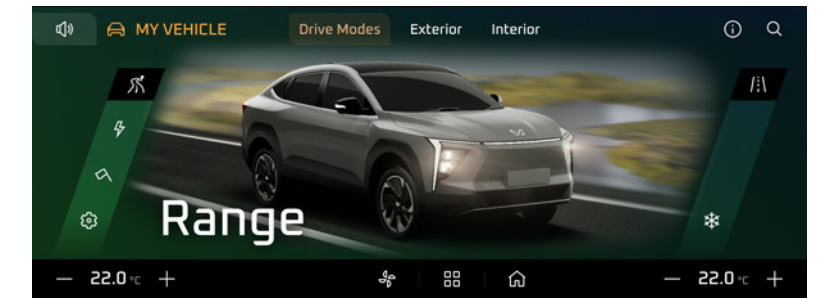





Interior seen is the XEV 9e

# ULTIMATE LEVEL OF PROTECTION

## Level 2+ Advanced Driver Assist Systems

Five radars and 12 ultrasonic sensors, all working in harmony to enable an advanced autonomous driving experience.

## Stay alert, stay safe

The Driver Occupant Monitoring System uses a wide field-of-view camera and advanced sensors to track your fatigue and overall well-being. It sends timely alerts and gentle reminders to ensure you stay focused, keeping everyone in the eSUV safe and comfortable.

## Your digital fortress

Secure360 provides advanced surveillance and protection, ensuring your eSUV is safe at all times.

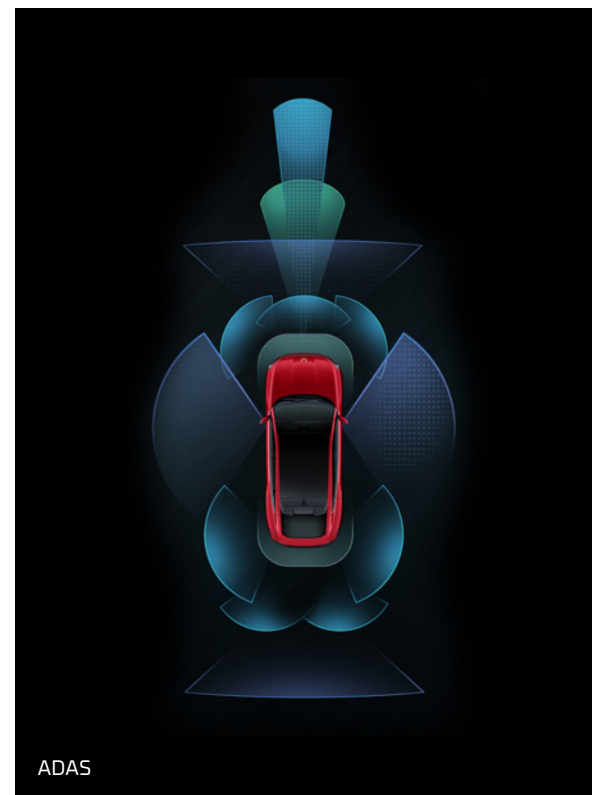

ADAS

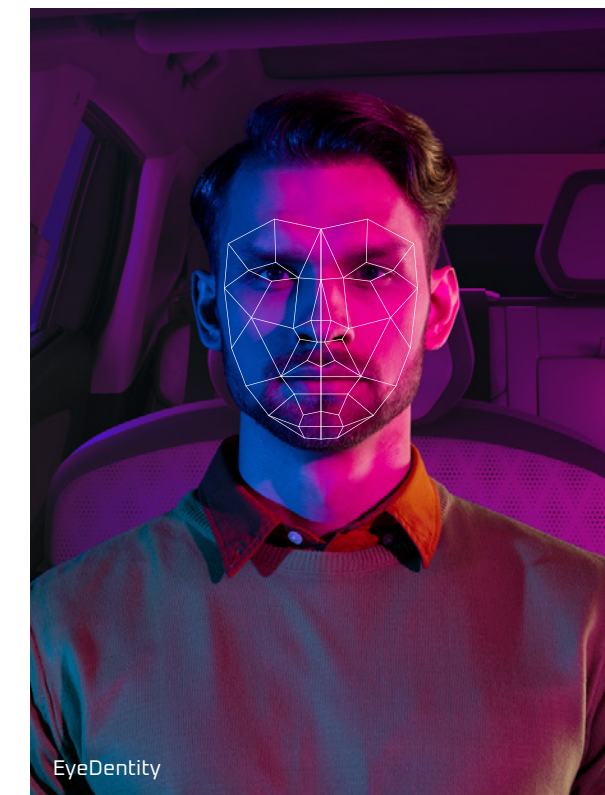

EyeDentity

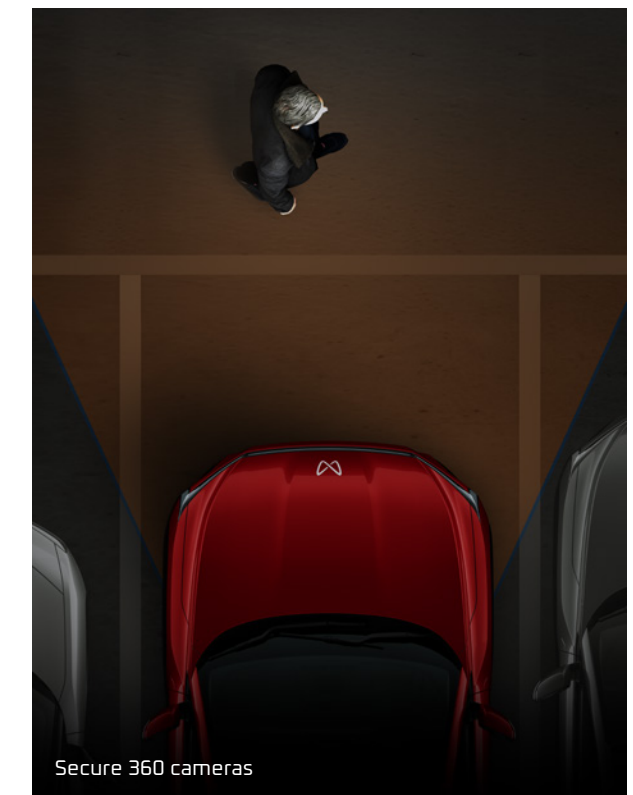

Secure 360 cameras



Charge 0 – 80% in 20 minutes using a 175 kW DC fast charger

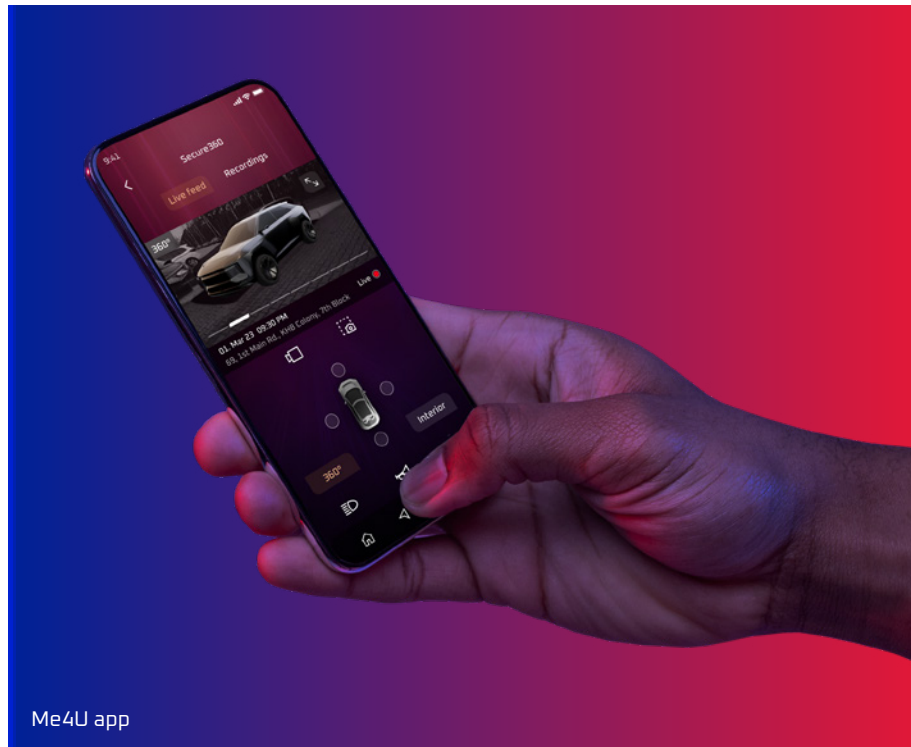

Me4U app

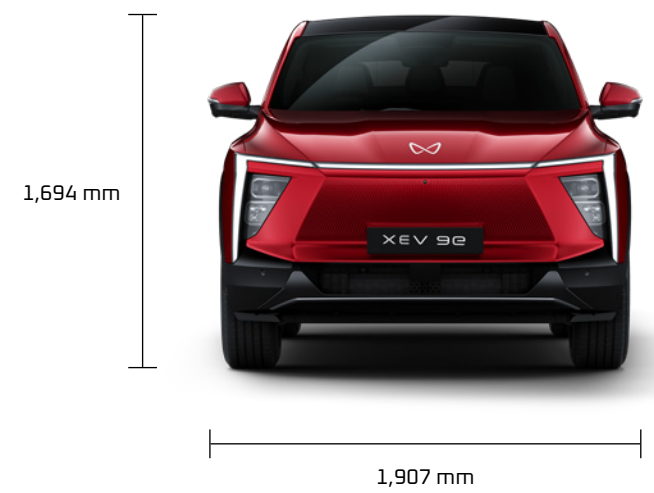



Car seen is the Mahindra XEV 9e in Tango Red

# UNTOLD POSSIBILITIES

SPECIFICATIONS	XEV 9e	
VARIANT	Pack ONE	Pack THREE
<b>Powertrain</b>		
Battery (kWh)	59	79
Motor power (kW)	170	210
Motor torque (Nm)	380	
Drive type	RWD	
Adjustable regen levels	L0, L1, L2, L3 (where L0 is 0 regen and L3 is max regen)	
Single pedal drive	Yes	
Drive modes	Range, Everyday, Race, Snow & Custom Mode	
Range (MIDC P1 + P2)	542 km	656 km
<b>Dimensions</b>		
L x W x H (mm)	4,789 × 1,907 × 1,694	
Wheelbase (mm)	2,775	
Ground clearance – unladen (mm)	207 (218 at battery)	
TCD (m)	10	
Boot volume (VDA – ISO V211)	663 litres	
Frunk volume	150 litres	
<b>Chassis and dynamics</b>		
Steering	Electric power steering with variable gear ratio	
Front suspension	McPherson Strut I-Link independent suspension and stabiliser bar	
Rear suspension	Multi-Link (5-Link) independent suspension and stabiliser bar	
Suspension damper type	Passive suspension with FDD & MTV-CL tech*	Intelligent adaptive suspension

\*FDD - Frequency Dependent Damping, MTV-CL tech - Multi Tuned Valve - Concentric Land technology.

SPECIFICATIONS	XEV 9e	
VARIANT	Pack ONE	Pack THREE
<b>Chassis and dynamics (continued)</b>		
Brakes	Disc (front and rear)	
Wheels and tyres	245/55 R19 (Stylised wheel)	245/55 R19 Alloy (Optional 245/50 R20)
Spare wheel	T 135/80 R18	
<b>Charging</b>		
Charger type / charging standard	CCS2	
AC portable charger	13A (up to 3.2kW), compatible with household 3-pin 16A socket	
AC wall charger	7.2kW & 11kW options	
AC charging time (0–100% soc)	6 / 8.7 h (11 kW / 7.2 kW charger)	8 / 11.7 h (11 kW / 7.2 kW charger)
DC charging time (20–100% soc)	20 min (with 140 kW charger input)	20 min (with 180 kW charger input)
<b>Warranty</b>		
HV battery pack	Lifetime warranty**	

\*\* For First Registered Owner. Applicable for Private Registration only. In case of ownership change, warranty on HV Battery shall be 10 years or 2,00,000 km - whichever is earlier.

FEATURES	XEV 9e	
VARIANT	Pack ONE	Pack THREE
<b>Design</b>		
Bi LED projector headlamps	S	
CapTouch switches	Switch bank on dashboard	Steering wheel & switch bank on dashboard
Centre signature (position) lamp	-	S
Coast-to-Coast triple super screens (12.3" x 3)	S	
Electrically deployed front door handles	-	S
Frunk with drain hole	With intermediate lid	
Illuminated logo (front & rear)	S	
Infinity Roof - fixed glass panoramic sunroof	-	S
LED DRLs	Lit as position lamp	S
LED tail lamp	S	
LightMeUp (ambient lights)	-	Dashboard, door trims & unique patterns on Infinity Roof
ORVM turn indicators	S	
Premium finish exterior cladding	S	
Rear spoiler	S	
Seat upholstery	Premium fabric	Leatherette
Sequential turn indicators	-	S
Soft wrapped dashboard & door trims	-	Mid inserts & top rolls
Start up / goodbye animations	-	S
Steering wheel	-	Leatherette
Wheels & tyres	245/55 R19 (Stylised wheel)	245/55 R19 Alloy (Optional 245/50 R20)

FEATURES	XEV 9e	
VARIANT	Pack ONE	Pack THREE
<b>Performance</b>		
Adjustable regen levels - L0, L1, L2, L3 & auto	S	
Boost Mode	S	
Cruise control	Standard cruise control	Adaptive cruise control
Multi drive modes	Range, Everyday, Race, Snow & Custom mode	
Single pedal drive	S	
Performance dashboard	S	

- = Not available S = Standard

FEATURES	XEV 9e	
VARIANT	Pack ONE	Pack THREE
<b>Infotainment &amp; technology</b>		
App store		S
Audio system	Std audio with 6 speakers & sound staging	Harman Kardon 16 speaker immersive audio
Built in Amazon Alexa & Chat GPT		S
BYOD – device mounting provision on seats	-	S
Charging limiter		S
Connected car suite (Me4U app)		S
Dolby Atmos	-	S
Ecosense & driving analytics		S
EyeDentity (Driver & Occupant Monitoring)	-	S
Full auto parking (from vehicle, with key fob and mobile app)	-	S
Fun&Work (Entertainment + work suite) 60+ In built OTT, Social Media, News, Shopping Apps		S
OTA updates (ePowertrain)		S
OTA updates (infotainment & maps)		S
OTA updates (vehicle features)		S
Scheduled charging & scheduled cabin conditioning		S
Sonic suite (signature sounds)		S
Superfast 5G in-vehicle connectivity		S
VenueScapes live	-	S
Video calling with in-car camera	-	S
Vision X (augmented reality HUD)	-	S
Wireless Android Auto & CarPlay		S
Wireless charger (15W with cooling)	-	Front & Rear

FEATURES	XEV 9e	
VARIANT	Pack ONE	Pack THREE
<b>Comfort &amp; convenience</b>		
12V conventional power socket in boot		S
2nd row 60:40 seat		S
2nd row AC vents		S
2nd row adj headrest		S
2nd row arm rest with cup holder		S
2nd row recline		Multi step
Auto AC	Single zone (FATC)	Dual zone (DATC)
Auto booster lamps	-	S
Auto dimming IRVM	-	S
Auto headlamps		S
Auto wipers		S
Console storage cooling		S
Cornering lamps	-	S
Driver seat with memory and welcome retract	-	S
Electric adjust ORVM		S
Electric park brake (EPB)		S
Front row arm rest with storage		S
Height adj driver seat	6 way manual	6 way powered + adj lumbar (manual)
In-Car Experience using your own device (BYOD) - via Me4U app		S
Keep, Pet & Camp modes (climate control)		S
Live Your Mood (Relax modes)		Club, Calm & Cosy
One touch up / down driver window	-	S

- = Not available S = Standard

FEATURES	XEV 9e	
VARIANT	Pack ONE	Pack THREE
<b>Comfort &amp; convenience (continued)</b>		
ORVM auto dip on reverse	-	S
Tonneau cover	-	S
Passive keyless entry (PKE)	-	S
Power fold ORVM	-	S
Power tailgate with gesture control	-	S
Push button start	S	
Rear window sun shade	-	S
Soft door arm rests	S	
Tilt & telescopic steering	S	
Type C USB data and charging port (front)	15W x 1	
Type C USB fast charging (front)	65W x 1	
Type C USB fast charging (rear)	65W x 2	
Tyre Pressure Monitoring System (TPMS)	Alert	With individual tyre pressure monitoring
Ventilated front seats	-	S

FEATURES	XEV 9e	
VARIANT	Pack ONE	Pack THREE
<b>Safety &amp; security</b>		
360 degree camera	-	S
Air purifier with PM 2.5 filter & AQI indicator	-	S
Airbags	6 airbags (front, side & curtain)	7 airbags (front, side, curtain & driver knee)
Blind view monitor	-	S
ESP	S	
Front fog lamps	-	S
Front park sensors	-	S
ISOFIX rear seats	S	
Level 2+ ADAS: 5 radars + 1 vision camera	-	S
Rear defogger	S	
Rear park sensors	S	
Reverse camera	S	
Secure 360 - live view & recording	-	S
Windshield auto defogging	-	S

- = Not available S = Standard







# UNLIMITED LUXURY

Discover the future of electric SUVs today. Get behind the wheel of the XEV 9e and find out what it really means to live without limits and drive with confidence.



# UNLIMIT LOVE



All features mentioned in the brochure are not available on all the variants of XEV 9e ("Vehicle"). Accessories shown on the Vehicle are not part of the standard configuration and needs to be purchased separately. Performance figures shown are based on internal tests done by the experts in controlled environment. Actual performance figures may vary due to various factors such as driving conditions, maintenance, etc. and may differ in conditions. The images of the Vehicle shown are creative visualisation and for illustrative purpose only. Tinted glass on the Vehicle is due to lighting effect. The colour of the Vehicle depicted in the image may differ from its actual appearance. Kindly visit your nearest Mahindra dealership to check the actual appearance of the Vehicle. Harman Kardon and all related marks are registered trademarks of Harman and or its affiliates. Dolby and all related marks are registered trademarks of Dolby and or its affiliates. Alexa feature is introduced to assist the Driver and improve the safety and convenience of driving a Vehicle. Alexa is only available in certain languages and regions. Alexa functionality may vary by location and variant of the Vehicle. Amazon, Alexa, and all related logos are trademarks of Amazon.com, Inc. or its affiliates. In view of our policy of continuously improving our products, we reserve the right to alter specifications or designs without prior notice and without liability to you. We reserve the right to add or delete any feature without prior notice and without any liability. The software and security mechanisms in the Vehicle are subject to ongoing developments. Like with computers or the operating systems of mobile devices, the software and security mechanisms in the Vehicle may also be updated at irregular intervals.



ELECTRIC ORIGIN  
SUVs

mahindra