

XEV 90 **CINÉLUXE**

An Experience Apart



ELECTRIC ORIGIN
SUVs

mahindra

CINELUXE SIGNATURES

Luxury Elevated in Every Frame.

Satin White & Satin Black Exterior.
Two signature finishes.

**Rich Chestnut Brown &
Nocturne Black Leatherette Interiors**
Warm sophistication that transforms
every journey into a lounge experience.



ENTERTAINMENT. ELEVATED.

Coast-to-coast three screen HD Display

A seamless digital horizon. Entertainment without edges.

16-Speaker Harman Kardon Audio with Dolby Atmos

Concert-hall clarity. Feel every note

LightMeUp + Infinity Roof

16 million ambient hues. Your sky. Your mood

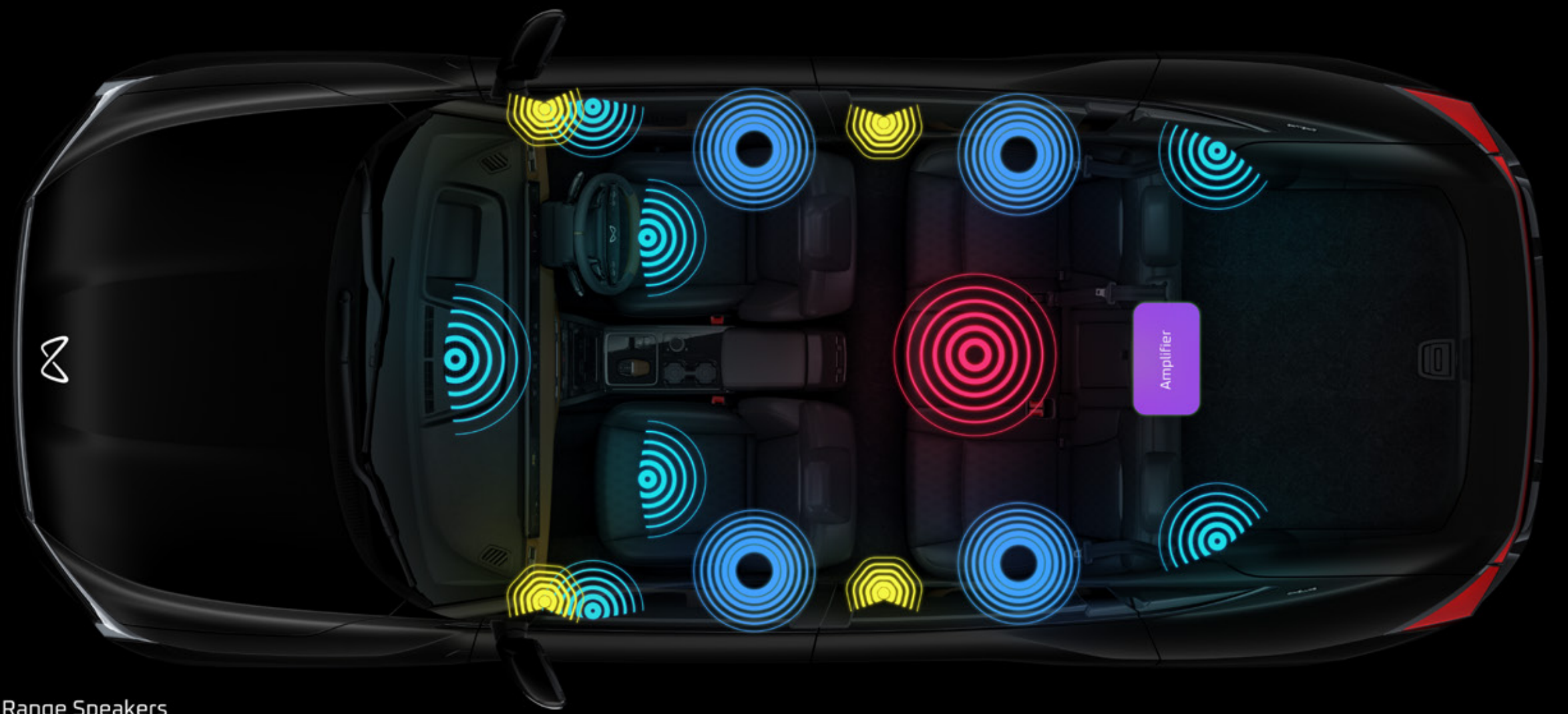

- Mid Range Speakers
- Woofers
- Tweeters
- Sub Woofer

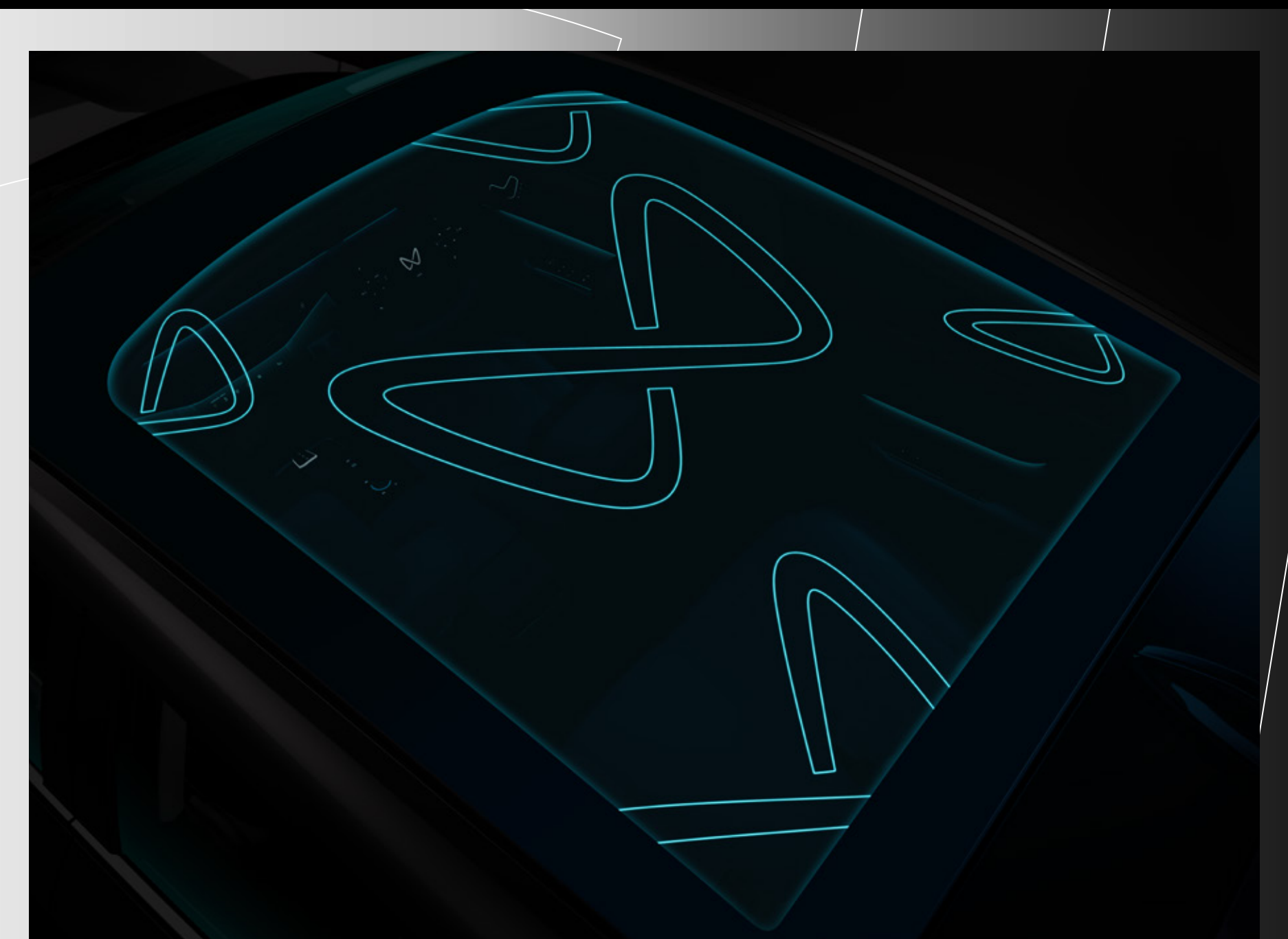

PERFORMANCE IN MOTION

79 kWh Battery

656 km certified range*
& 500+ km real-world range**

210 kW power & 380 Nm Torque

Pure Command. Effortless power.

Intelligent Adaptive Suspension

15 ms of real-time control
of damping force

Drive Modes

Default, Range, everyday,
Race & Custom.



* As per MIDC P1 + P2 certification – with the 79 kWh battery pack. ** As per tests conducted internally with moderate ambient temperature, City Drive with Low HVAC, Dry road and Optimal Drive.

INTELLIGENCE IN MOTION.

HandsFree™ Park (Auto Park Assist)
Precision, automated, perfected

StraightAhead™ Display (VisionX AR HUD)
Information, floating effortlessly in your line of sight.

Level 2+ ADAS
An unseen co-pilot. Watching what you might miss.

EyeDentity
Driver & occupant monitoring.

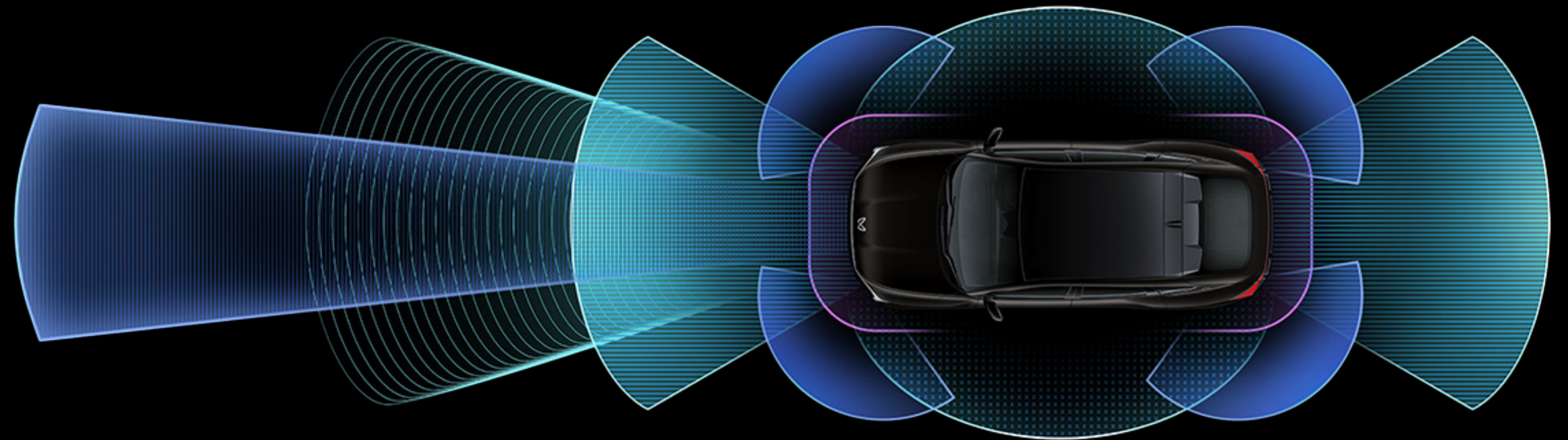

● Radar
● Ultra Sonic
● Camera

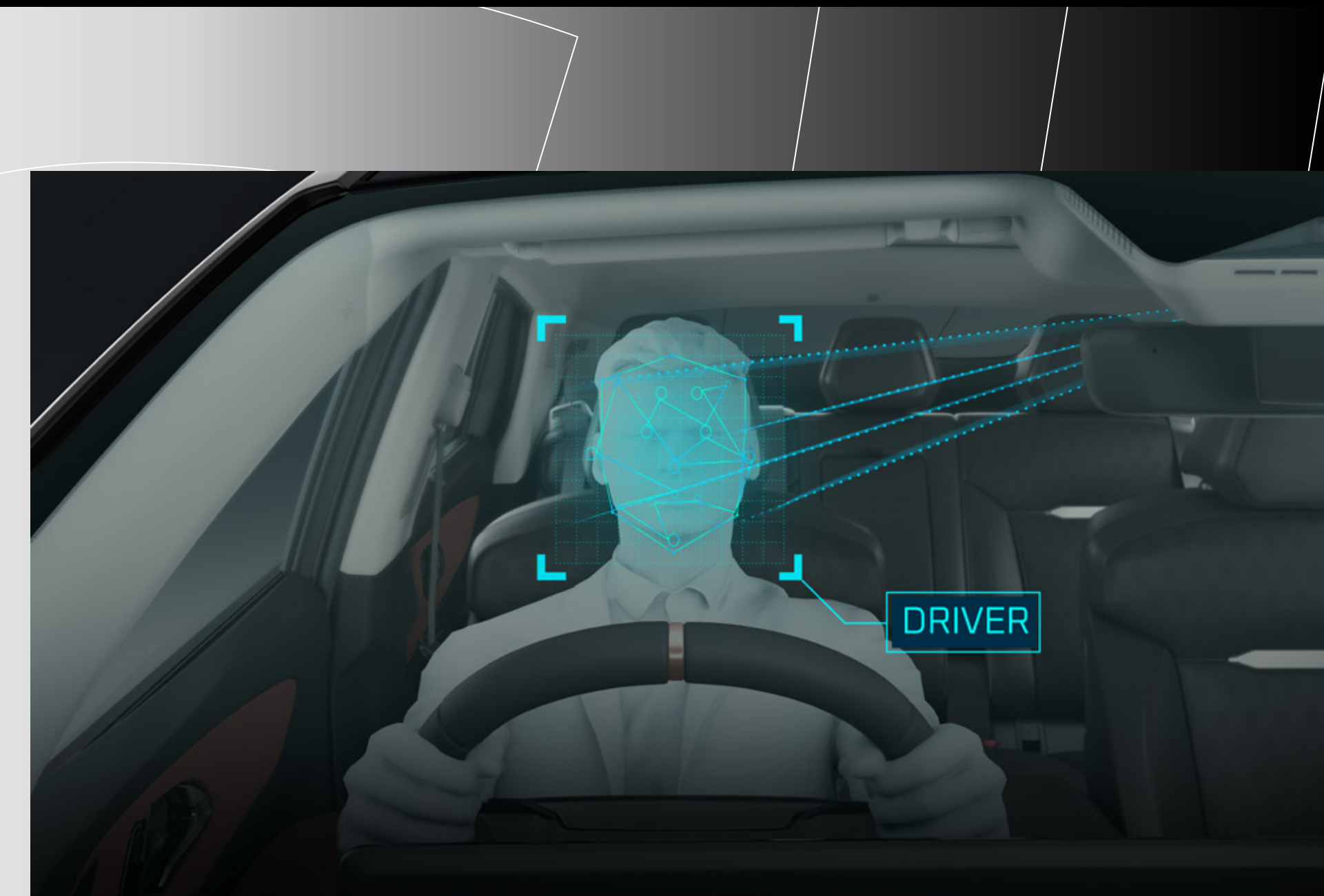

PERFORMANCE

- 79 kWh Battery Pack
- Superfast Charging Capability: 20 to 80% in just 20 min with 180 kW DC Charger
- Best-in-class Power of 210 kW
- Electric Power Steering with Variable Gear Ratio
- 10 metre Turning Circle Diameter
- Multiple Driving Modes with Boost Mode, Multi step regeneration, including Auto mode
- Adaptive Cruise Control
- One-touch Single Pedal Drive
- iLink Front Suspension & 5-Link Rear Suspension
- Intelligent Adaptive Suspension
- MTV-CL technology
- Low Rolling Resistance Tyres with NVH Reduction
- **Custom Drive Mode** ^{NEW}

DESIGN

- Illuminated Logo
- Bi-LED Projector Headlamps with LED DRLs
- LED Tail lamps
- LightMeUp - Ambient lighting with 16 Million colours – integrated in Interiors & Infinity Roof
- Night Trail - Carpet Lamps
- Coast-to-Coast Triple Super Screens (12.3"x3)
- Fixed Glass Infinity Roof
- LED DRLs with Centre Signature Lamp
- R19 Alloy Wheels
- Leatherette Seat Upholstery
- Leatherette Steering Wheel
- Soft wrapped Dashboard & Door Trims
- CapTouch switches on Steering wheel & switch bank on dashboard

- Sequential Turn Indicators
- Sequence Start up / goodbye animations
- Premium Finish Exterior Cladding

SAFETY

- 7 Airbags (6 Airbags + Driver Knee Airbag)
- L2+ ADAS with 5 Radars & 1 Vision Camera
- Forward Collision Warning System (FCW)
- Automatic Emergency Braking System (AEB)
- Lane Departure Warning System (LDW)
- Lane Keep Assist System (LKA)
- Lane Sway Alert (LSA)
- Lane Centering Function (LCF)
- Traffic Sign Recognition (TSR)
- Front Vehicle Start Alert (FVSA)
- Adaptive Cruise Control (ACC)
- Intelligent Adaptive Cruise Control (iACC)
- Smart Pilot Assist (SPA)
- High Beam Assist (HBA)
- Forward Cross Traffic Alert (FCTA)
- Rear Cross Traffic Alert (RCTA)
- Autonomous Emergency steering (AES)
- Evasive steering Assist (ESA)
- Emergency Lane Keep Assist
- Blind Spot Detection (BSD)
- Highway Assist (including Driver Initiated Auto Lane Change)
- Rear Collision Warning (RCW)
- Front & Rear Park Sensors
- 360 Degree camera
- Blind View monitor

- Air Purifier with PM 2.5 filter & AQI indicator
- **Continuous DVR (Digital Video Recorder)** ^{NEW}
- **Secure360 Pro – Live view, recording & Audio Relay.** ^{NEW}

INFOTAINMENT & TECHNOLOGY

- 16 Speaker Harman Kardon Audio System
- Dolby Atmos
- VenueScapes Live
- Sonic Suite (Signature Sounds)
- StraightAhead™ Display (VisionX AR HUD)
- HandsFree™ Park (Auto Park Assist)
- EyeDentity (Driver & Occupant Monitoring)
- Wireless charger (15W with cooling)
- Wireless Android Auto & CarPlay
- Built in Amazon Alexa & Chat GPT
- Superfast 5G in-vehicle connectivity
- "Fun&Work (Entertainment + work suite)
- 60+ In built OTT, Social Media, News, Shopping Apps"
- Video Calling with In-Car Camera
- Connected car Suite (Me4U App)
- In-Car Experience' using your own Device (BYOD) - via Me4U app

COMFORT & CONVENIENCE

- 6 way powered Height adj Driver seat + adj lumbar (Manual)
- 2nd row 60:40 Seat
- Ventilated Front Seats

- Co Driver Ergo Lever
- Driver seat with memory and welcome retract
- 2nd Row Adj Headrest
- 2nd Row recline (Multi step)
- Dual Zone Auto AC
- 2nd row AC vents
- Live Your Mood (Relax modes)
- Console Storage Cooling
- ORVM Auto Dip on Reverse
- Push Button Start
- Passive Keyless Entry (PKE)
- **NFC Key Compatibility** ^{NEW}
- EPB (Electric Park Brake)
- Cornering Lamps
- Auto booster Lamps
- Auto Headlamps
- Tilt & Telescopic Steering
- Power tailgate with gesture control
- Rear window Sun Shade
- One touch up/dn driver window
- Tyre Pressure Monitoring System (TPMS)
- Tonneau Cover
- **Smart Climate Control – PawPal (Pet Mode), CampMe (Camp Mode), Keep Mode** ^{NEW}
- Acoustic Laminated Door Glass
- **User Profile** ^{NEW}
- **Approach Unlock** ^{NEW}
- **Walkaway Lock** ^{NEW}
- **Charge Scheduler** ^{NEW}



SPECIFICATIONS

XEV 9e - CINELUXE

Variant	Pack THREE
Colour	Satin Black & Satin White
POWERTRAIN	
Battery (kWh)	79
Motor power (kW)	210
Motor torque (Nm)	380
Drive type	RWD
Adjustable regen levels	L0, L1, L2, L3 (Where L0 is No regeneration and L3 is Max regeneration) & Auto
Single pedal drive	Yes
Drive modes	Default, Range, Everyday, Race & Custom Mode
Range (MIDC P1 + P2)	656 km
DIMENSIONS	
L x W x H (mm)	4,789 x 1,907 x 1,694
Wheelbase (mm)	2,775
Ground clearance – unladen (mm)	207 (218 at battery)
TCD (m)	10
Boot volume (VDA – ISO V211)	663 litres
Frunk volume	150 litres
CHASSIS AND DYNAMICS	
Steering	Electric power steering with variable gear ratio
Front suspension	McPherson Strut I-Link independent suspension and stabiliser bar
Rear suspension	Multi-Link (5-Link) independent suspension and stabiliser bar
Suspension damper type	Intelligent adaptive suspension with MTV-CL tech*
Brakes	Disc (front and rear)
Wheels and tyres	245/55 R19 Alloy
Spare wheel	T 135/80 R18
CHARGING	
Charger type / charging standard	CCS2
Ac portable charger	13 A (up to 3.0 kW), compatible with household 3-pin 16 A socket
Ac wall charger	11.2 kW
AC charging time (0–100% SoC)**	8 h (11.2 kW charger)
DC charging time (20–80% SoC)**	20 min (with 180 kW 400 A charger input)
WARRANTY	
HV battery pack	Lifetime warranty***



XEV 90 **CINÉLUXE**



Disclaimer: Accessories shown in the brochure are not part of standard configuration and need to be purchased separately. Performance figures displayed throughout the brochure and on all marketing material are based on independent testing conducted by experts in controlled environments. Actual performance will vary depending on external factors such as driving conditions, maintenance, etc. The images of the vehicles displayed throughout the brochure and in all marketing material are creative visualizations and for illustrative purposes only. Tinted glass on the vehicle displayed in the brochure is due to lighting effects. The colour of the vehicle displayed in the brochure and in all marketing materials may differ from its actual appearance. Kindly visit your nearest authorised Mahindra dealership to check the actual appearance of the vehicle.

XEV 9e



ELECTRIC ORIGIN
SUVs

—
mahindra

EXPERIENCE SUAVE INDULGENCE



For those who move with bold confidence, the go-getters, the self-assured, the ones who redefine success on their own terms. The XEV 9e is an extension of your discerning taste, an embodiment of minimal sophistication and elegance in motion.



Car seen is the Mahindra XEV 9e in Tango Red

REMEMBER TO BREATHE

The ultimate expression of sophistication and performance, offering a suave SUV coupé design that seamlessly blends luxury with boldness.



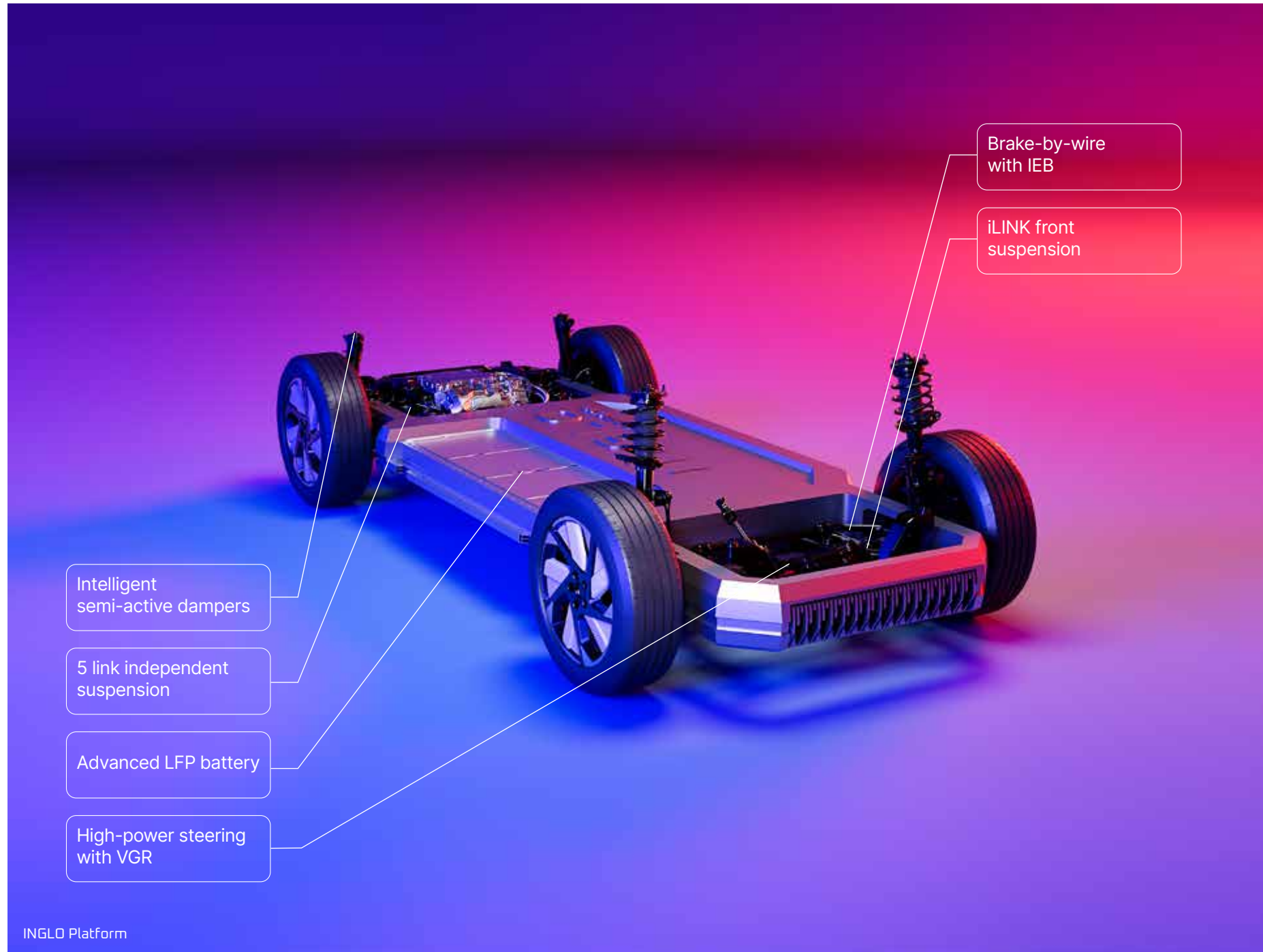

INGLO – ELECTRIC ORIGIN ARCHITECTURE

Benchmark in innovation with 152 patents*
and 45 design registrations*



Combining indomitable Indian spirit with global standards and ambition, this unique architecture is as adaptable as it is innovative. A universe of advanced components integrated seamlessly to deliver exceptional range, power, handling.

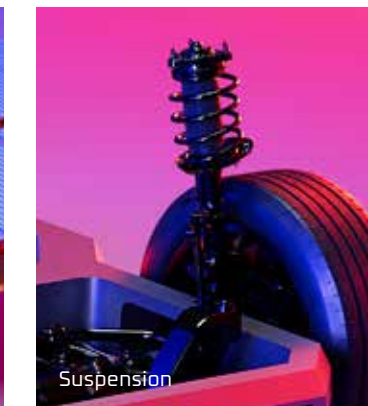
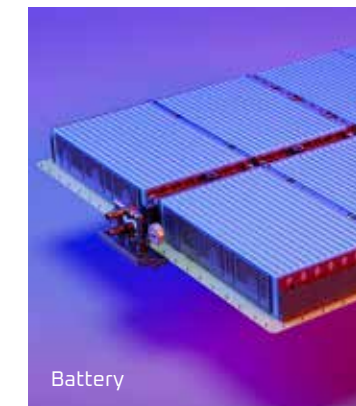
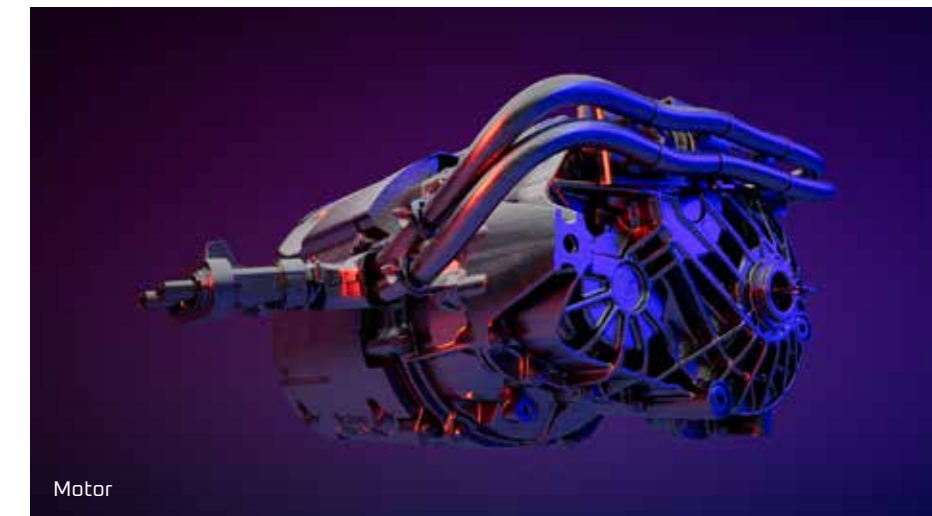

*Patents and design registrations applied.

SAFETY IS IN OUR DNA

Seven airbags with reinforced BIW structure

FRONTAL CRASH PROTECTION

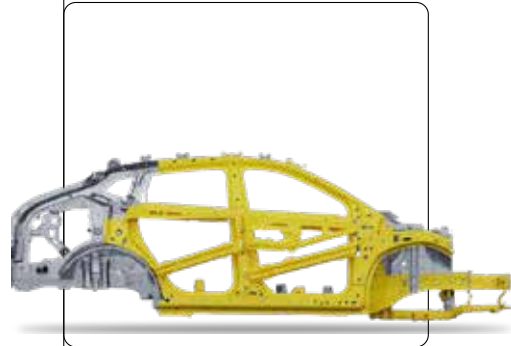

30g peak deceleration

400 kJ impact energy

SIDE CRASH PROTECTION



7 AIRBAGS



Car seen is the Mahindra XEV 9e in Tango Red

BATTERY ROBUSTNESS

Extensive testing	14,577 HOURS	55+ LAKH KM
-------------------	--------------	-------------



HV safety: Robust battery pack testing to ensure safety from electric shocks.

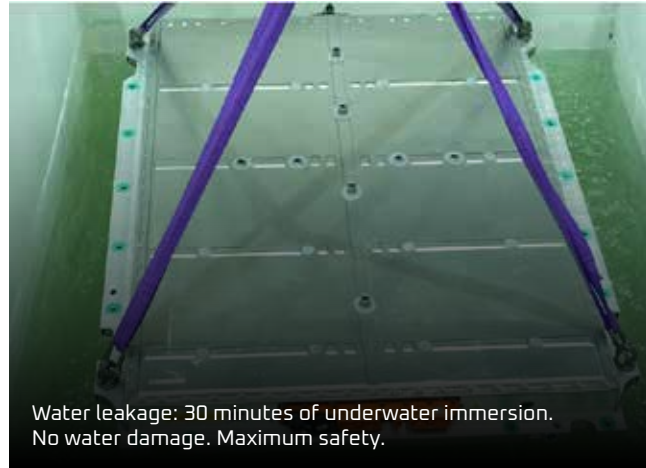

Water leakage: 30 minutes of underwater immersion. No water damage. Maximum safety.



Thermal: Set on fire for 3 minutes. 900 degrees celsius of obliterating heat. No fire observed in the battery.

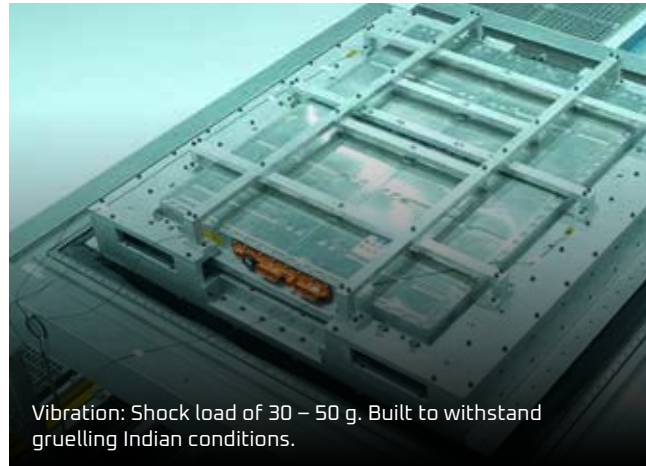

Vibration: Shock load of 30 – 50 g. Built to withstand gruelling Indian conditions.

The performance figures, specifications, and features mentioned in this brochure, including but not limited to speed, fuel efficiency, acceleration, and other technical details, have been tested and recorded under controlled conditions and may vary depending on driving conditions, vehicle load, maintenance, and other factors. Actual performance may differ from the values mentioned due to real-world variables.



Car seen is the Mahindra XEV 9e in Tango Red



Car seen is the Mahindra XEV 9e in Tango Red

656 KM RANGE IN A SINGLE CHARGE*

500+ km real-world range in metro driving conditions with AC on (79 kWh battery).

Vehicle	Battery capacity	MIDC – P1 + P2 (ARAI certification)
XEV 9e	79 kWh	656 km
	59 kWh	522 km

500+ km real-world range ensures you only need to charge once a week**

Bengaluru 508	Jaipur 491	Trivandrum 518
Coimbatore 559	Chandigarh 539	Kochi 499
Chennai 529	Delhi 515	Mysore 501
Hyderabad 504	Kolkata 546	Mangalore 499
Pune 503	Bhubaneshwar 527	Goa 553
Ahmedabad 497	Vizag 517	Mumbai 497
Udaipur 529	Rajahmundry 540	Nashik 512

* As per MIDC P1 + P2 certification – with the 79 kWh battery pack.
 ** As per tests conducted internally with moderate ambient temperature, City Drive with Low HVAC, Dry road and Optimal Drive Mode.

UNMATCHED PERFORMANCE

Refinement is the XEV 9e's essence. Every detail, every angle, every surface is crafted to captivate. Designed to take your breath away and engineered for absolute control, it delivers a driving experience defined by elegance, power, and precision. Perfection, made effortless.

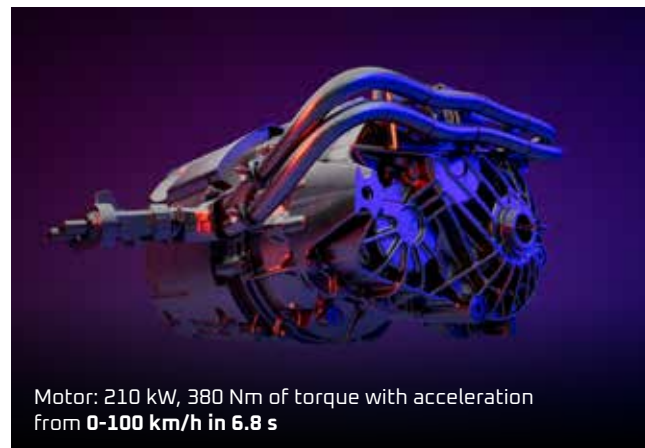

The performance figures, specifications, and features mentioned in this brochure, including but not limited to speed, fuel efficiency, acceleration, and other technical details, have been tested and recorded under controlled conditions and may vary depending on driving conditions, vehicle load, maintenance, and other factors. Actual performance may differ from the values mentioned due to real-world variables.





Car seen is the Mahindra XEV 9e in Tango Red

BEST-IN-CLASS CABIN SPACE

The XEV 9e is engineered for maximum comfort and convenience. Stretch out, relax, and embrace the freedom of limitless ease.



Spacious frunk: 150 L

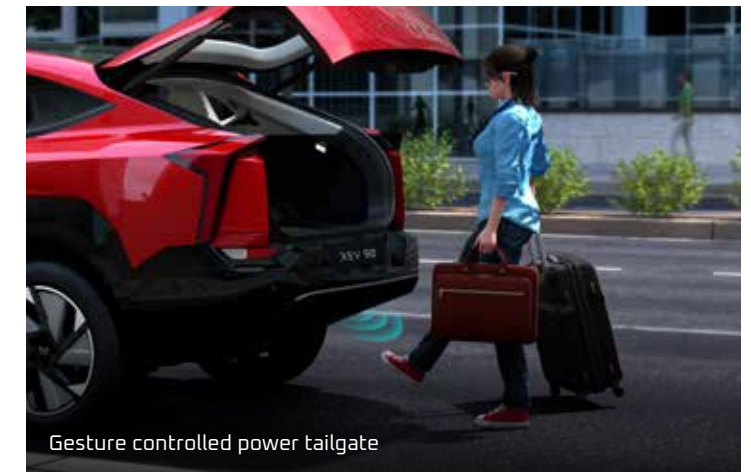

Gesture controlled power tailgate



Expansive cabin space: 1617 L



Boot space: 663 L

STAY COOL, CALM AND PROTECTED

99.5%* UV ray filtration, a whisper-quiet cabin and, best-in-class air conditioning – all in one world-class eSUV



Best-in-class air conditioning: The XEV 9e is equipped with a super-fast air conditioning system that has 95% PM 2.5 filtration efficiency with a VR-led smart air purifier.



Whisper-quiet cabin: Enjoy uninterrupted conversations in the XEV 9e, even at speeds of up to 130 km/h.



Interior seen is the XEV 9e

The performance figures, specifications, and features mentioned in this brochure, including but not limited to speed, fuel efficiency, acceleration, and other technical details, have been tested and recorded under controlled conditions and may vary depending on driving conditions, vehicle load, maintenance, and other factors. Actual performance may differ from the values mentioned due to real-world variables.

*Unmatched UV protection: Maximum filtration of UV rays that blocks 99.5% UV rays (200 – 400 nm).



Interior seen is the XEV 9e

THE FASTEST MIND IN THE AUTOMOTIVE WORLD

MAIA, inspired by the Sanskrit name for "Magic", is designed to assist you with your everyday needs.

4 HPC CHIPS

Enable high performance computing for a safe and enhanced driving experience

**12 SENSORS
5 RADARS**

Ensure a safe driving experience with Level 2+ Advanced Driver Assist Systems technology

ZONAL ARCHITECTURE

Allows for OTA updates of features and technology

**51 TOPS
75 MLOC**

51 trillion operations per second, real-time responses, advanced safety and driver assistance

24 GB RAM

Lightning-fast performance, enabled to handle multiple tasks

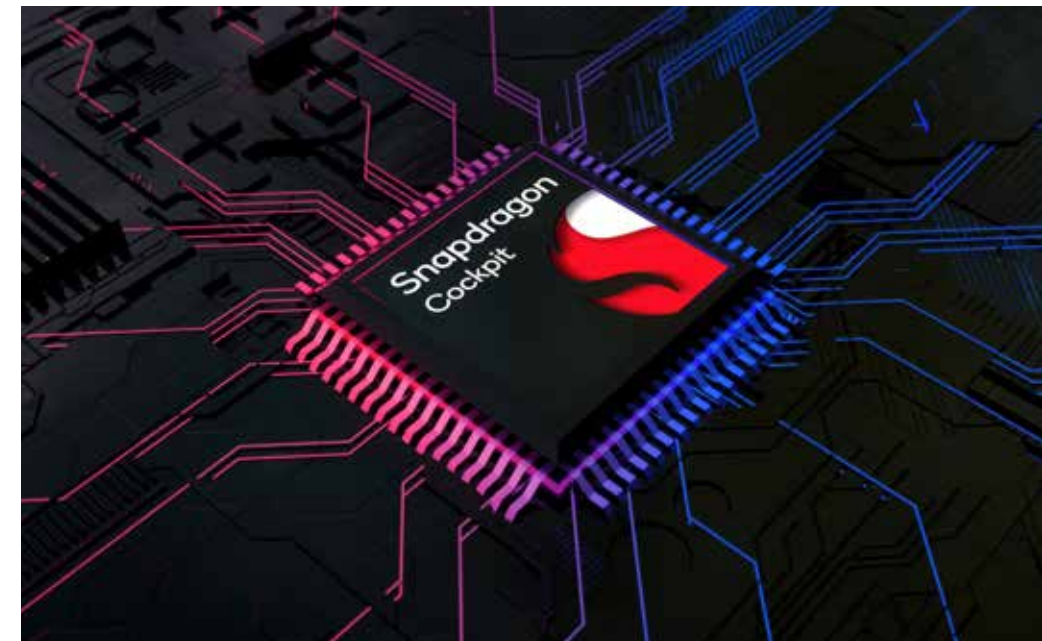

THE ADVANCED SOFTWARE ARCHITECTURE OF MAIA



MAIA is the neural network – the brain – of our eSUVs. Derived from the Sanskrit word for magic, MAIA conjures incredible power from AI and high-performance computing to deliver an unmatched driving experience. At its heart is the Qualcomm Snapdragon 8295 chipset, a technological marvel built on a 5 nm process node, achieving 200K DMIPS, 46 TOPS, and 3000 GFLOPS. This powerhouse effortlessly handles billions of commands and complex tasks in real time, ensuring instant responsiveness, fluid performance, and intelligence that anticipates all your needs.



MAIA – THE FASTEST MIND IN THE MOBILE WORLD



Processor	MAIA	Luxury phone
CPU	220K DMIPS	110K DMIPS
GPU	3100 GFLOPS	2227 GFLOPS
NPU	51 TOPS	35 TOPS



Entertainment

WIDE CINEMASCOPE, THREE-SCREEN, HIGH- DEFINITION DISPLAY

The XEV 9e redefines sophistication with a cockpit that seamlessly blends elegance and technology. A triple-screen layout caters to both driver and front passenger, creating an environment that is as refined as it is functional. The two-spoke steering wheel, with touch-operated buttons and a subtle illuminating effect, remains understated when off and comes alive when you're ready to drive. Comfortable, beautifully padded front seats and a spacious, elevated cabin envelop you in striking luxury. Designed for control, crafted for comfort. The XEV 9e's cockpit is where refinement meets innovation.



Interior seen is the XEV 9e

LIVE IN FULL COLOUR

Live Your Mood

Three immersive modes that transport you to a different world, depending on your mood. Calm Mode helps you find some peace, whenever you seek it. Leave stress behind and embrace tranquillity. Experience the ultimate in comfort and relaxation with Cozy Mode – your personal haven on wheels. Club Mode transforms your eSUV into a concert on wheels. Club Mode, making every journey unforgettable. Your eSUV. Your club.



Live Your Mood

LightMeUp + Infinity Roof

16 million hues in the sky, all yours with the Infinity Roof. Indulge in panoramic vistas and customise your ambience with our sophisticated ambient lighting system.

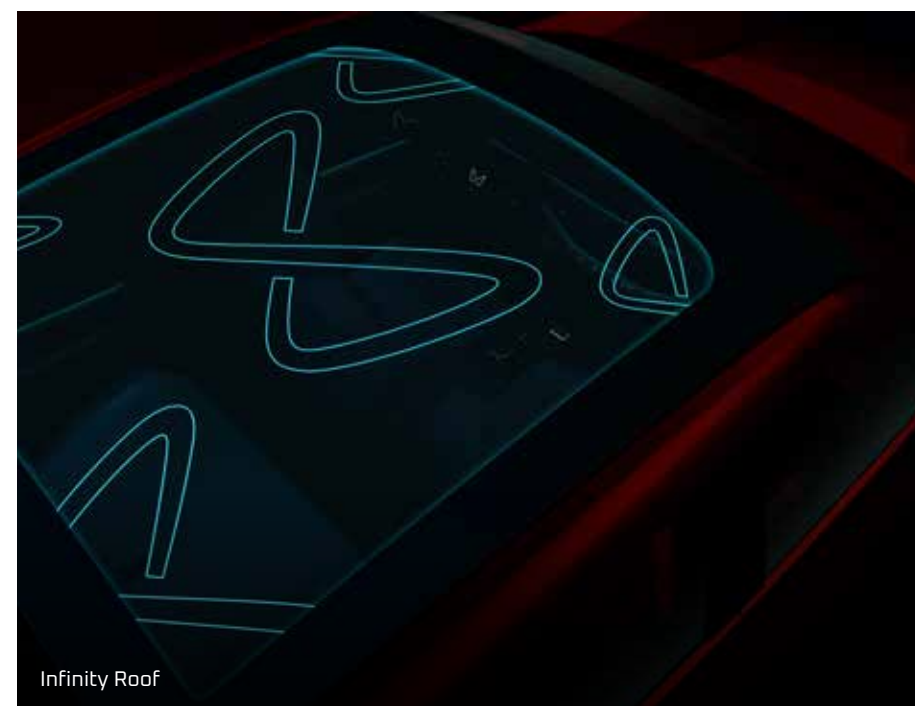

Infinity Roof



LightMeUp
Interior seen is the XEV 9e



- Mid Range Speakers
- Tweeters
- Woofers / Subwoofer
- Amplifier

Car seen is the Mahindra XEV 9e in Tango Red

1400 WATT, 16-SPEAKER HARMAN KARDON WITH DOLBY ATMOS

Mahindra Sonic Studio

Hear every note, feel every beat. The 16-speaker Harman Kardon sound system with Dolby Atmos surrounds you with crystal-clear audio, making every drive feel like a concert.



Interior seen is the XEV 9e

AUTOPARK* – PARKING MADE EFFORTLESS

AutoPark takes the wheel, so you don't have to break a sweat.

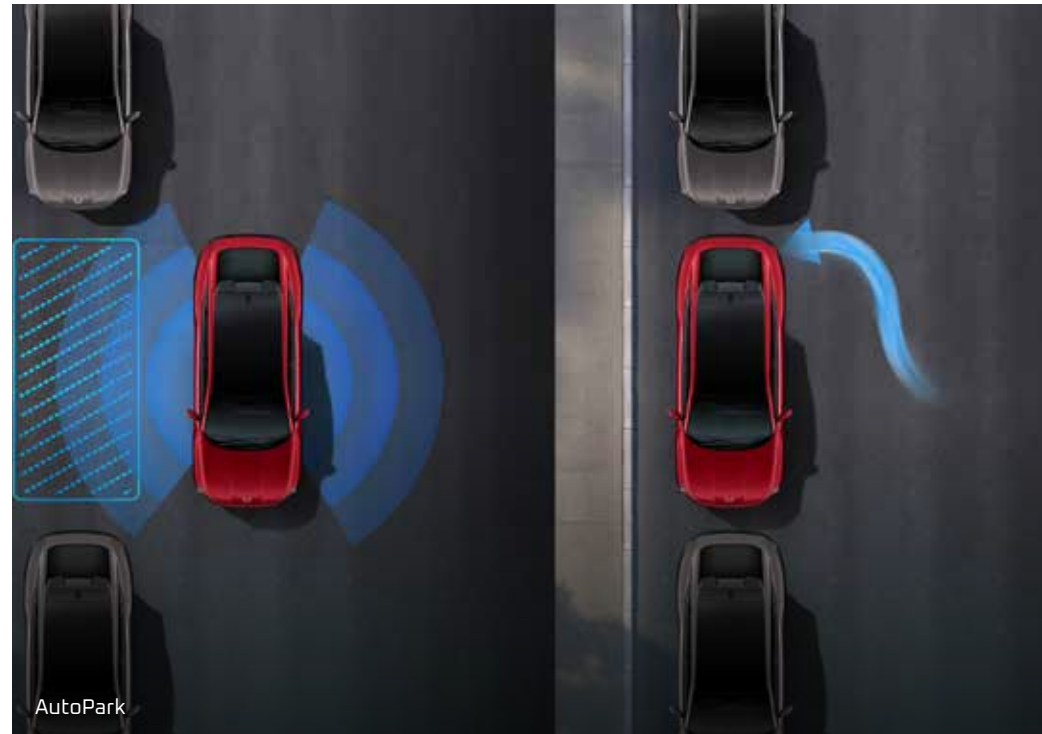

FROM ECO TO EGO

Choose your driving style with modes that adapt to road conditions and your performance parameters.





Interior seen is the XEV 9e

ULTIMATE LEVEL OF PROTECTION

Level 2+ Advanced Driver Assist Systems

Five radars, 12 ultrasonic sensors and one camera, all working in harmony to enable an advanced autonomous driving experience.

Stay alert, stay safe

The Driver Occupant Monitoring System uses a wide field-of-view camera and advanced sensors to track your fatigue and overall well-being. It sends timely alerts and gentle reminders to ensure you stay focused, keeping everyone in the eSUV safe and comfortable.

Your digital fortress

Secure360 provides advanced surveillance and protection, ensuring your eSUV is safe at all times.

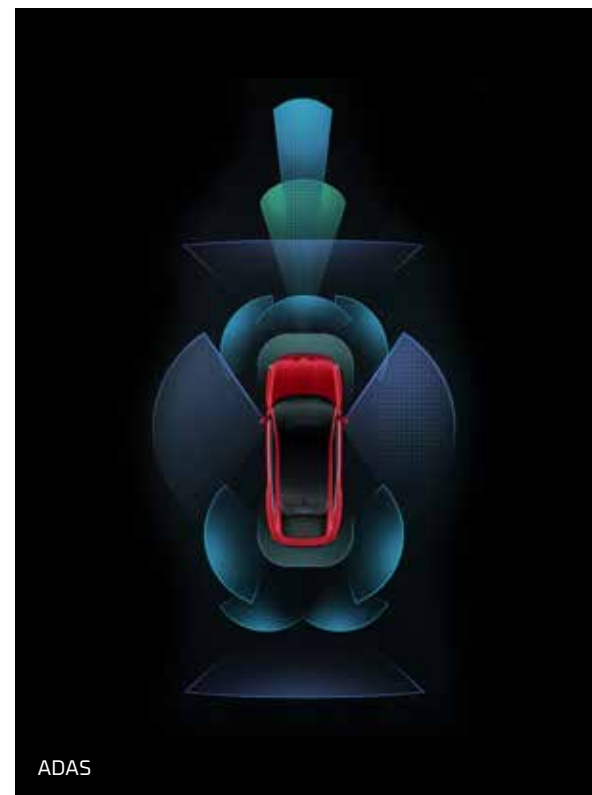

ADAS



EyeDentity



Secure 360 cameras



Charge – 20% to 80% SOC with 180 kW 400A charger input

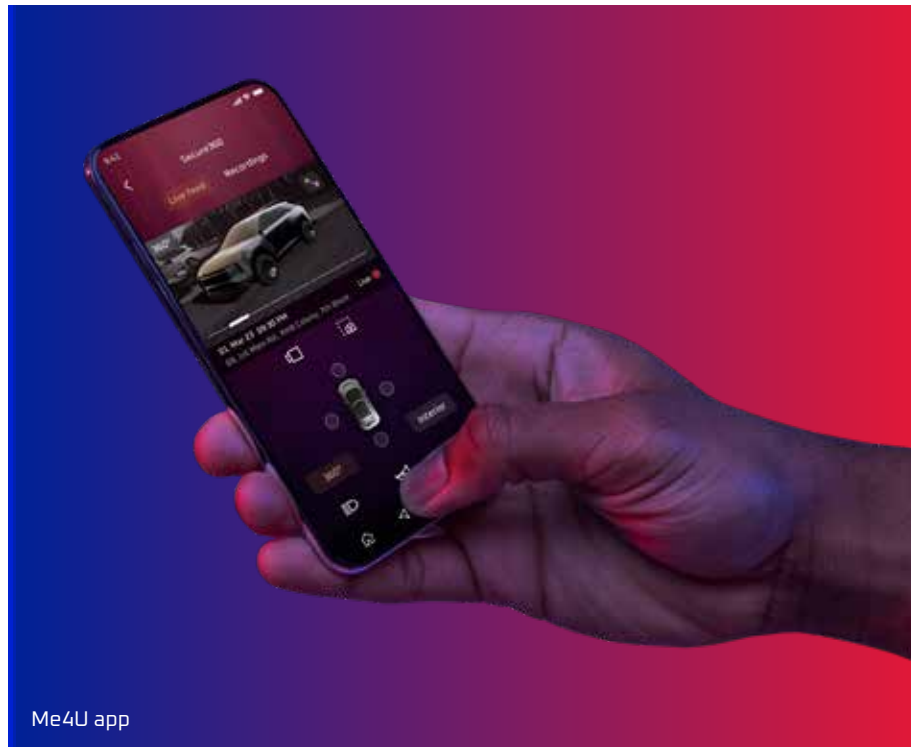

Me4U app



Wall charger





Car seen is the Mahindra XEV 9e in Tango Red

EXTERIOR COLOURS



Tango Red



Nebula Blue



Desert Myst



Deep Forest



Ruby Velvet



Everest White



Stealth Black

UNTOLD POSSIBILITIES

SPECIFICATIONS	XEV 9e			
VARIANT	Pack ONE	Pack TWO	Pack THREE SELECT	Pack THREE
Powertrain				
Battery (kWh)	59	59, 79	59	79
Motor power (kW)	170	170,210	170	210
Motor torque (Nm)	380	380	380	380
Drive type	RWD			
Adjustable regen levels	L0, L1, L2, L3 (Where L0 is No regeneration and L3 is Max regeneration) & Auto			
Single pedal drive	Yes			
Drive modes	Default, Range, Everyday, Race & Snow Mode			
Range (MIDC P1 + P2)	522 km	522, 656 km	522 km	656 km
Dimensions				
L x W x H (mm)	4,789 × 1,907 × 1,694			
Wheelbase (mm)	2,775			
Ground clearance – unladen (mm)	207 (218 at battery)			
TCD (m)	10			
Boot volume (VDA – ISO V211)	663 litres			
Frunk volume	150 litres			
Chassis and dynamics				
Steering	Electric power steering with variable gear ratio			
Front suspension	McPherson Strut I-Link independent suspension and stabiliser bar			
Rear suspension	Multi-Link (5-Link) independent suspension and stabiliser bar			
Suspension damper type	Passive suspension with FDD & MTV-CL tech*	Passive suspension with FDD & MTV-CL tech*	Intelligent adaptive suspension with MTV-CL tech*	Intelligent adaptive suspension with MTV-CL tech*

*FDD – Frequency Dependent Damping, MTV-CL tech – Multi Tuned Valve – Concentric Land technology.

SPECIFICATIONS	XEV 9e			
VARIANT	Pack ONE	Pack TWO	Pack THREE SELECT	Pack THREE
Chassis and dynamics (continued)				
Brakes	Disc (front and rear)			
Wheels and tyres	245/55 R19 (Stylised wheel)	245/55 R19 Alloy	245/55 R19 Alloy	245/55 R19 Alloy
Spare wheel	T 135/80 R18			
Charging				
Charger type / charging standard	CCS2			
Ac portable charger	13A (up to 3.0kW), compatible with household 3-pin 16A socket			
Ac wall charger	7.2kW & 11kW options	7.2kW & 11kW options	7.2kW & 11kW options	7.2kW & 11kW options
Ac charging time (0–100% SoC)**	6 / 8.7 h (11.2 kW / 7.2 kW charger)	6 / 8.7 h (11.2 kW / 7.2 kW charger)	6 / 8.7 h (11.2 kW / 7.2 kW charger)	6 / 8 / 11.7 h (11.2 kW / 7.2 kW charger)
Dc charging time (20–80% SoC)**	20 min (with 140kW 400A charger input)	20 min (with 140kW 400A charger input)	20 min (with 140kW 400A charger input)	20 min (with 180kW 400A charger input)
Warranty				
Hv battery pack	Lifetime warranty***			

** DC and AC Charging times will vary based on ambient temperature, battery temperature, Air Conditioning operation & voltage output from the charger.

***For First Registered Owner. Applicable for Private Registration only. In case of ownership change, warranty on HV Battery shall be 10 years or 2,00,000 km – whichever is earlier.

FEATURES	XEV 9e			
VARIANT	Pack ONE	Pack TWO	Pack THREE SELECT	Pack THREE
Design				
Bi LED projector headlamps	S	S	S	S
LED DRLs	Lit as position lamp	S	S	S
Illuminated logo (front & rear)	S	S	S	S
Centre signature (position) lamp	-	S	S	S
LED tail lamp	S	S	S	S
Sequential turn indicators	-	S	S	S
Start up / goodbye animations	-	S	S	S
Night Trail (carpet lamp)	-	-	-	S
CapTouch switches	Switch bank on dashboard	Switch bank on dashboard	Steering wheel & switch bank on dashboard	Steering wheel & switch bank on dashboard
Soft wrapped dashboard & door trims	-	-	-	S
Seat upholstery	Premium fabric	Leatherette	Leatherette	Leatherette
Steering wheel & e-shifter	Leatherette (e-Shifter)	Leatherette	Leatherette	Leatherette
Rear spoiler	S	S	S	S
Electrically deployed front door handles	-	-	S	S
ORVM turn indicators	S	S	S	S
Frunk with drain hole	S	S	S	S
Frunk Intermediate Lid	N*	N*	N*	S
Wheels & tyres	245/55 R19 (Stylised wheel)	245/55 R19 alloy	245/55 R19 alloy	245/55 R19 alloy

-- = Not available S = Standard

N* - Available as an accessory.

FEATURES	XEV 9e			
VARIANT	Pack ONE	Pack TWO	Pack THREE SELECT	Pack THREE
Performance				
Cruise control	Standard cruise control	Adaptive cruise control	Adaptive cruise control	Adaptive cruise control
Multi drive modes	Default, Range, Everyday, Race & Snow mode	Default, Range, Everyday, Race & Snow mode	Default, Range, Everyday, Race & Snow mode	Default, Range, Everyday, Race & Snow mode
Boost Mode	S	S	S	S
Adj regen levels – L0, L1, L2, L3 & auto	S*	S	S	S
Single pedal drive	S	S	S	S
Performance dashboard	S	S	S	S
Infotainment & technology				
Audio system	Std audio with 6 speakers & sound staging	Harman Kardon 16 speaker immersive audio	Harman Kardon 16 speaker immersive audio	Harman Kardon 16 speaker immersive audio
Dolby Atmos	-	S	S	S
VenueScapes live	-	S	S	S
Sonic suite (signature sounds)	S	S	S	S
Vision X (augmented reality HUD)	-	-	-	S
Full auto parking (from vehicle, with key fob and mobile app)	-	-	S	S
EyeDentity (Driver & occupant Monitoring)	-	-	S	S
Wireless charger (15W with cooling)	-	Front	Front & Rear	Front & Rear
Wireless Android Auto & CarPlay	S	S	S	S
Built in Amazon Alexa & Chat GPT	S	S	S	S
Superfast 5G in-vehicle connectivity	S	S	S	S
Fun&Work (entertainment + work suite) 60+ in built OTT, social media, news, shopping apps	S	S	S	S

-- = Not available S = Standard

*Auto not applicable.

FEATURES	XEV 9e			
VARIANT	Pack ONE	Pack TWO	Pack THREE SELECT	Pack THREE
Infotainment & technology (continued)				
Video calling with in-car camera	–	–	S	S
Connected car suite (Me4U app)	S	S	S	S
In-Car Experience using your own device (BYOD) – via Me4U app	S	S	S	S
BYOD – device mounting provision on seats	–	S	S	S
OTA updates (infotainment & maps)	S	S	S	S
OTA updates (vehicle features)	S	S	S	S
OTA updates (ePowertrain)	S	S	S	S
Charging limiter	S	S	S	S
Scheduled charging & scheduled cabin conditioning	S	S	S	S
Ecosense & driving analytics	S	S	S	S
App store	S	S	S	S
Comfort & convenience				
Height adj driver seat	6 way manual	6 way powered + adj lumbar (manual)	6 way powered + adj lumbar (manual)	6 way powered + adj lumbar (manual)
2nd row 60:40 seat	S	S	S	S
Ventilated front seats	–	–	S	S
Co driver ergo lever	–	–	S	S
Driver seat with memory and welcome retract	–	S	S	S
Front row arm rest with storage	S	S	S	S
2nd row arm rest with cup holder	S	S	S	S
Soft door arm rests	S	S	S	S
2nd row adj headrest	S	S	S	S

-- = Not available S = Standard

FEATURES	XEV 9e			
VARIANT	Pack ONE	Pack TWO	Pack THREE SELECT	Pack THREE
Comfort & convenience (continued)				
2nd row recline	Multi step	Multi step	Multi step	Multi step
Auto AC	Single zone (FATC)	Dual zone (DATC)	Dual zone (DATC)	Dual zone (DATC)
2nd row AC vents	S	S	S	S
Live Your Mood (Relax modes)	Club, Calm & Cosy	Club, Calm & Cosy	Club, Calm & Cosy	Club, Calm & Cosy
Console storage cooling	S	S	S	S
Auto dimming IRVM	–	S	S	S
Electric adjust ORVM	S	S	S	S
Power fold ORVM	–	S	S	S
ORVM auto dip on reverse	–	S	S	S
Push button start	S	S	S	S
Passive keyless entry (PKE)	–	–	S	S
Electric Park Brake (EPB)	S	S	S	S
Cornering lamps	–	S	S	S
Auto booster lamps	–	S	S	S
Auto headlamps	S	S	S	S
Auto wipers	S	S	S	S
Type C USB data cum charge port (front)	15W x 1	15W x 1	15W x 1	15W x 1
Type C USB fast charging (front)	65W x 1	65W x 1	65W x 1	65W x 1
Type C USB fast charging (rear)	65W x 2	65W x 2	65W x 2	65W x 2

-- = Not available S = Standard

FEATURES	XEV 9e			
VARIANT	Pack ONE	Pack TWO	Pack THREE SELECT	Pack THREE
Comfort & convenience (continued)				
12V conventional power socket in boot	S	S	S	S
Tilt & telescopic steering	S	S	S	S
Power tailgate with gesture control	-	-	S	S
Rear window sun shade	-	-	S	S
One touch up / down driver window	-	-	S	S
Tyre pressure monitoring system (TPMS)	Alert	With individual tyre pressure monitoring	With individual tyre pressure monitoring	With individual tyre pressure monitoring
Tonneau cover	N*	N*	N*	S
Safety & security				
Airbags	6 airbags (front, side & curtain)	6 airbags (front, side & curtain)	7 airbags (front, side, curtain & driver knee)	7 airbags (front, side, curtain & driver knee)
ISOFIX rear seats	S	S	S	S
ESP	S	S	S	S
ADAS	--	1 Radar + 1 Vision Camera	1 Radar + 1 Vision Camera	1 Radar +1 Vision Camera + 4 Corner Radars
Forward collision warning system (FCW)	-	S	S	S
Automatic emergency braking system (AEB)	-	S	S	S
Lane departure warning system (LDW)	-	S	S	S
Lane keep assist system (LKA)	-	S	S	S
Lane sway alert (LSA)	-	S	S	N/A
Lane centering function (LCF)	-	S	S	S
Traffic sign recognition (TSR)	-	S	S	S
Front vehicle start alert (FVSA)	-	S	S	S
Adaptive cruise control (ACC)	-	S	S	S
Intelligent adaptive cruise control (iACC)	-	S	S	S

-- = Not available S = Standard

N* - Available as an accessory.

FEATURES	XEV 9e			
VARIANT	Pack ONE	Pack TWO	Pack THREE SELECT	Pack THREE
Safety & security (continued)				
Smart pilot assist (SPA)	-	S	S	S
Driver Drowsiness Detection (DDD)	S	S	S	S
High beam assist (HBA)	-	S	S	S
Forward cross traffic alert (FCTA)	-	-	-	S
Rear cross traffic alert (RCTA)	-	-	-	S
Door open alert (DOA)	-	-	-	S
Autonomous emergency steering (AES)	-	-	-	S
Evasive steering assist (ESA)	-	-	-	S
Emergency lane keep assist	-	-	-	S
Blind spot detection (BSD)	-	-	-	S
Highway assist (including driver initiated auto lane change)	-	-	-	S
Rear collision warning (RCW)	-	-	-	S
Rear park sensors	S	S	S	S
Front park sensors	-	S	S	S
Reverse camera	S	S	S	S
360 degree camera	-	-	S	S
Blind view monitor	-	-	S	S
Secure 360 – live view & recording	-	-	S	S
Front fog lamps	-	S	S	S
Rear defogger	S	S	S	S
Windshield auto defogging	-	S	S	S
Air purifier with PM 2.5 filter & AQI indicator	-	-	S	S

The Connected car subscription is available to the customer at no additional cost for a period of one year from the date of delivery. This includes 20GB/month in-car data that ensures seamless experiences to Fun&Work apps (OTT streaming, social media, News, Shopping Apps, video calling etc). Once the data consumption reaches to 90% of monthly limit, in-car data access to Fun&Work apps will be temporarily restricted until the next month's data allocation begins. However, if you wish to continue using these apps, you have the option to purchase additional data (recharge) to restore access.

-- = Not available S = Standard



UNLIMITED LUXURY

Discover the future of electric SUVs today. Get behind the wheel of the XEV 9e and find out what it really means to live without limits and drive with confidence.



UNLIMIT LOVE



V31

All features mentioned in the brochure are not available on all the variants of XEV 9e ("Vehicle"). Accessories shown on the Vehicle are not part of the standard configuration and needs to be purchased separately. Performance figures shown are based on internal tests done by the experts in a controlled environment. Actual performance figures may vary due to various factors such as driving conditions, maintenance, etc. and may differ in conditions. The images of the Vehicle shown are creative visualisation and for illustrative purpose only. Tinted glass on the Vehicle is due to lighting effect. The colour of the Vehicle depicted in the image may differ from its actual appearance. Kindly visit your nearest Mahindra dealership to check the actual appearance of the Vehicle. Harman Kardon and all related marks are registered trademarks of Harman and or its affiliates. Dolby and all related marks are registered trademarks of Dolby and or its affiliates. 'Android Auto' is a trademark of Google LLC & its affiliates. 'Apple Carplay' is a trademark of Apple Inc. and its affiliates. Please note that our eSUVs may not come equipped with Apple CarPlay and Android Auto at the time of launch. These features may be introduced later through a software update. For the latest information on feature availability, please contact your nearest dealership. 'Snapdragon' & 'Snapdragon Cockpit' are a trademark of Qualcomm Inc. and its affiliates. Alexa feature is introduced to assist the Driver and improve the safety and convenience of driving. Alexa is only available in certain languages and regions. Alexa functionality may vary by location and variant of the Vehicle. Amazon, Alexa, and all related logos are trademarks of Amazon.com, Inc. or its affiliates. In view of our policy of continuously improving our products, we reserve the right to alter specifications or designs without prior notice and without liability to you. We reserve the right to add or delete any feature without prior notice and without any liability. The software and security mechanisms in the Vehicle are subject to ongoing developments. Like with computers or the operating systems of mobile devices, the software and security mechanisms in the Vehicle may also be updated at irregular intervals.

